



testo 558s – digital manifold

0564 5581

Instruction manual



Contents

1	About this document	5
2	Safety and disposal.....	6
2.1	Product-specific information	8
2.2	Disposal	10
3	Product-specific approvals	10
4	Intended use	10
5	Product description	11
5.1	Overview of the testo 558s.....	11
5.2	Overview of main menu.....	12
5.3	Measurement menu	13
5.4	Control keys	14
6	First steps	15
6.1	Charging the rechargeable battery	15
6.2	Inserting batteries.....	16
6.3	Switching the instrument on and off	16
6.4	Setup wizard	17
7	Using the product.....	18
7.1	Preparing for measurement.....	18
7.1.1	Operating the valve positioners.....	18
7.1.2	Automatic mode	18
7.2	Measuring mode.....	19
7.2.1	Refrigeration.....	19
7.2.2	Evacuation	23
7.2.3	Pressure Leak Test	26
7.2.4	Target Superheat	29
7.2.5	Compressor Test (DLT).....	33
7.2.6	Delta T.....	35
7.3	Performing long time measurement	37
7.4	Refrigerant charging.....	38
7.4.1	Manual charging via weight.....	39
7.4.2	Automatic charging by target weight	41
7.4.3	Automatic charging by subcooling.....	44
7.4.4	Automatic charging by superheat.....	47
7.5	Bluetooth	50
7.5.1	Probes compatible with the instrument.....	50
7.5.2	Establishing a connection.....	51
7.5.3	Switching on/off.....	51

Contents



7.5.3.1	Switching on	52
7.5.3.2	Switching off	52
7.5.3.3	Manual probe selection.....	53
7.6	Settings.....	54
7.6.1	Screen Auto Off	54
7.6.2	Auto Tfac (Temperature compensation factor)	56
7.6.3	Units	57
7.6.4	Language.....	58
7.6.5	Setup Wizard	59
7.6.6	Restore factory settings	60
7.6.7	Device Info.....	61
8	Smart App.....	62
8.1	App – user interface.....	62
8.2	Main menu.....	63
8.3	Measurement menu.....	64
8.3.1	Basic view.....	64
8.3.1.1	Graphic view	65
8.3.1.2	Table view	66
8.3.2	Refrigeration	67
8.3.3	Target superheat	71
8.3.4	System Leak Test	73
8.3.5	Evacuation.....	76
8.4	Customer	77
8.4.1	Creating and editing a customer.....	77
8.4.2	Creating and editing measuring sites.....	78
8.5	Memory.....	80
8.5.1	Searching for and deleting measurement results.....	80
8.6	Sensors	81
8.6.1	Information.....	81
8.6.2	Settings.....	82
8.7	Settings.....	82
8.7.1	Language.....	82
8.7.2	Measurement settings	82
8.7.3	Company details	83
8.7.4	Privacy settings.....	83
8.8	Help and Information	84
8.8.1	Instrument information	84
8.8.2	Tutorial.....	84

8.8.3	Exclusion of liability	84
8.9	testo DataControl archiving software.....	85
8.9.1	System requirements	85
8.9.1.1	Operating system	85
8.9.1.2	PC	85
8.9.2	Procedure.....	86
9	Maintenance.....	88
9.1	Calibration	88
9.2	Cleaning the instrument	88
9.3	Keeping connections clean	88
9.4	Removing oil residues.....	88
9.5	Ensuring measuring accuracy	88
9.6	Changing batteries batteries	89
9.7	Removing the permanently installed battery	90
10	Technical data	93
11	Tips and assistance	97
11.1	Questions and answers.....	97
11.2	Error Codes.....	97
11.2.1	Main screen.....	97
11.2.2	Status view.....	98
11.3	Accessories and spare parts	98
12	Support	98

1 About this document

- The instruction manual is an integral part of the instrument.
- Pay particular attention to the safety instructions and warning advice in order to prevent injury and damage to the product.
- Please read this instruction manual through carefully and familiarize yourself with the product before putting it to use.

Symbols and writing standards

Display	Explanation
	Note: basic or further information
	Warning advice, risk level according to the signal word: Danger! Risk of death! Warning! Serious physical injury may occur. Caution! Minor physical injury or damage to the equipment may occur. Attention! Indicates possible damage to equipment > Take the specified precautionary measures.
1 2 ...	Action: several steps, the sequence must be followed
-	Result of an action
✓	Requirement
>	Action
Menu	Elements of the instrument, the instrument display or the program interface.
[OK]	Control keys of the instrument or buttons of the program interface.

Warnings

Always pay attention to any information marked with the following warning notices along with warning pictograms. Implement the specified precautionary measures!

DANGER

Risk of death!

WARNING

Indicates possible serious injury.

CAUTION

Indicates possible minor injury.

ATTENTION

Indicates possible damage to equipment.

2 Safety and disposal

General safety instructions

- Always operate the product properly, for its intended purpose and within the parameters specified in the technical data. Do not use any force.
- Do not commission the instrument if there are signs of damage on the housing.
- Dangers may also arise from the systems being measured or the measuring environment: Make sure you comply with the locally valid safety regulations when carrying out measurements.
- Do not expose the product to temperatures above 50 °C (122 °F).
- Do not store the product together with solvents. Do not use any desiccants.
- Only maintenance and repair work that is described in the documentation may be carried out on this instrument. Follow the prescribed steps exactly when doing the work. Only use original spare parts from Testo.

Built-in rechargeable battery

DANGER

Risk of death!

The built-in rechargeable battery can explode if it gets too hot.

- Do not expose the product to ambient temperatures above 50°C.

- Battery cover must always be closed while operating.
- Improper use of batteries may cause destruction of the batteries, injuries due to current surges, fire or the escape of chemicals.
- Do not deform batteries. Batteries must not be squashed, drilled, dismantled, pierced, modified or damaged in any other way. This may lead to the leakage of battery acid, to the escape of gases and/or to an explosion.
- Do not heat batteries above the permitted temperature or burn them. If a battery is heated, this may lead to the leakage of battery acid and/or to an explosion. Lithium batteries can, for instance, react very strongly in combination with fire. This may involve battery components being emitted with considerable power.
- Do not consume the battery; risk of burns due to hazardous substances. Keep new and used batteries away from children.
- In principle, contact with escaping battery components may present a risk to health and to the environment. Adequate body and respiratory protection is therefore required when in contact with batteries that exhibit abnormalities (escaping contents, deformations, discolourations, dents or the like).
- Batteries must be disposed of in accordance with the local and country-specific regulations. In order to prevent short circuits and the associated heating, lithium batteries must never be stored unprotected in bulk. Appropriate measures against short circuits are, for instance, inserting the batteries into the original packaging or a plastic bag, masking the poles or embedding them in dry sand.
- Lithium batteries must be transported and shipped in accordance with the local and country-specific regulations.
- If there is any contact with the skin or eyes, the areas must be rinsed with water for at least 15 minutes. If there is any contact with the eyes, a doctor must be contacted in addition to the rinsing.
- If burns are caused, these must be treated appropriately. You are also strongly advised to contact a doctor.
- Airways: leave the room immediately when smoke development or gas release is acute. Consult a doctor when amounts are larger and airways are irritated.
- Swallowing: rinse out mouth and surrounding area with water. Get medical assistance immediately.

2.1 Product-specific information

ACHTUNG

The measuring instrument being dropped or any other comparable mechanical stress may cause breakage of the pipe pieces in the refrigerant hoses. The valve positioners may also suffer damage, causing further damage inside the measuring instrument that is not necessarily visible externally.

- Therefore, always replace the refrigerant hoses with new ones after the measuring instrument is dropped or after any comparable mechanical stress.
- For your own safety, you should return the measuring instrument to the Testo Customer Service for technical inspection.

ACHTUNG

Electrostatic charging may destroy the instrument.

- Integrate all the components (system, manifold's valve block, refrigerant bottle, etc.) into the potential bonding (earthing).
- Please see the safety instructions for the system and the refrigerant used.

VORSICHT

Refrigerant gases can harm the environment.

- Please note the applicable environmental regulations.

Explosion hazard when using A2, A2L and A3 refrigerants

During maintenance and repair work on refrigeration systems with flammable refrigerants (e.g. category A2L, A2 and A3 of ISO 817), a hazardous and explosive atmosphere must always be expected in the immediate vicinity of the system. The **testo 558s** may only be operated outside of designated, recognizable or assumed explosion hazard zones (acc. to IEC 60079-10-1).

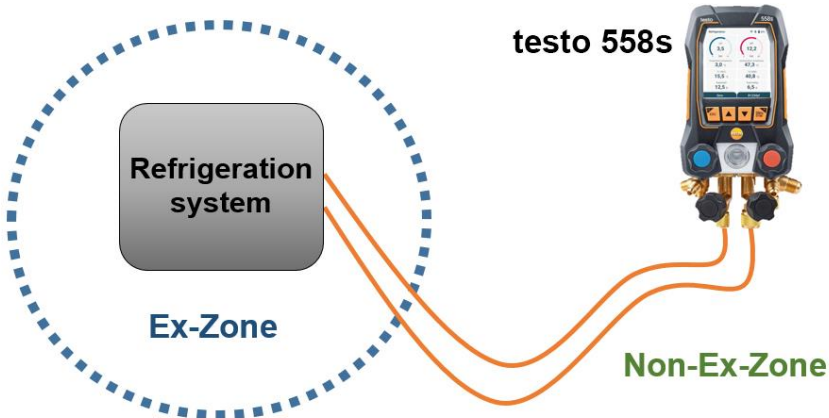

The following occupational safety measures must be observed to avoid a hazardous explosive atmosphere (see also: TRBS 1112, TRBS 2152 and VDMA 24020-3):

- Wear protective goggles and gloves.
- Before applying pressure to the measuring instrument: Always attach the measuring instrument to the suspension device to prevent it from falling down (risk of breakage).
- Before each measurement, check that the refrigerant hoses are intact and correctly connected.
Do not use any tools to connect the hoses, only hand-tighten the hoses (max. torque 5.0 N·m / 3.7 ft·lb).
- Adhere to the permissible measuring range (-1...60 bar/-14.7...870 psi). Pay particular attention to this for systems with refrigerant R744, as these are often operated at higher pressures!
- Open and close valves on the unit in the correct sequence to prevent any leakage of refrigerant from the system throughout the commissioning, maintenance and repair period.

2.2 Disposal

- Dispose of faulty/spent batteries in accordance with the valid legal specifications.
 WEEE Reg. Nr. DE 75334352
- At the end of its useful life, deliver the product to the separate collection point for electric and electronic devices (observe local regulations) or return the product to Testo for disposal.

3 Product-specific approvals

For the relevant country approvals, please refer to the printed quick reference guides or short instructions enclosed with the products.

4 Intended use

The measuring instrument **testo 558s** is a digital manifold for maintenance and service work on refrigeration systems that are set up, maintained and operated in accordance with the provisions of EN 378:2021-06 Part 1-4. It may only be used by qualified personnel.

The safety instructions in the operating manual of the refrigeration system, the refrigerant manufacturer and the measuring device must be followed.

The functions of the instrument **testo 558s** mean it can replace mechanical manifolds, thermometers and pressure/temperature charts. Pressures and temperatures can be applied, adapted, tested and monitored.

With its integrated logging function the device can be left on the system and logging can be done without being on site.

The combination of rechargeable battery and exchangeable batteries allows dual power operation.

The instrument **testo 558s** is compatible with most non-corrosive refrigerants, water and glycol. The instrument **testo 558s** is not compatible with refrigerants containing ammonia.

The **testo 568s** must not be used out of specified pressure and/or operation temperature range.

The product must not be used in potentially explosive atmospheres!

WARNING

Under no circumstances should the manifold be used as a pressure reducing valve, especially when nitrogen N₂ is used.





5 Product description

5.1 Overview of the testo 558s



1	Mini-DIN probe socket for NTC temperature probe, with socket cover	2	USB-C port for firmware update and charging rechargeable battery
3	Touch display. Instrument status icons (Touch display can be used as an alternative to the operating buttons for operation and configuration)	4	Rear: <ul style="list-style-type: none"> • Battery compartment • Foldable suspension device
5	Control keys	6	Sight glass for refrigerant flow
7	4 x valve positioner	8	4 x hose bracket for refrigerant hoses
9	Connection 7/16" UNF, brass. High pressure, for refrigerant hoses with quick-release screw fitting, passage can be closed via valve positioner.	10	Connection 5/8" UNF, brass, for vacuum pump
11	Connection 7/16" UNF, brass, e.g. for refrigerant cylinders, with sealing cap	12	Connection 7/16" UNF, brass. Low pressure, for refrigerant hoses with quick-release screw fitting, passage can be closed via valve positioner.

Symbol explanation

	Observe operating instructions
	Declaration of conformity: Products marked with this symbol comply with all applicable Community regulations of the European Economic Area.
	Australian test symbol
	Symbol of the Bluetooth® Special Interest Group (SIG)
	Do not dispose of old devices with household waste

5.2 Overview of main menu

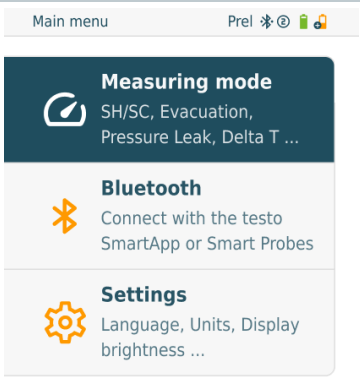
	
Measuring mode	Superheat/Subcooling Evacuation Pressure Leak Test Refrigerant Charging Target Superheat Compressor Test (DLT) Delta T
Bluetooth®	Connection to the testo Smart App or Smart Probes
Settings	Display brightness Screen Auto Off Auto Tfac (Temperature compensation factor) Units Language Setup Wizard

Factory reset
Instrument information

5.3 Measurement menu

Depending on the selected measurement mode, the measurement menu displays the relevant measured values.

- ▶ Tap on a displayed measured value.

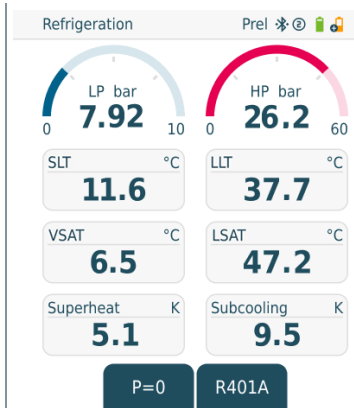

- ▶ A graphical view opens in which the last 30 minutes of the respective measured value can be viewed.

By tapping on another measured value below the graph, this is also displayed in the graph.

The displayed measured values are highlighted below the graph in the color of their graphical representation.





A maximum of two values can be displayed graphically at the same time.

5.4 Control keys



With the touch display of testo 558s it is possible to scroll in the menus like on a smartphone. Alternatively the control keys can be used.

Symbol	Meaning
	<ul style="list-style-type: none"> • Open menu • Confirm input • Switch on the display illumination: Press and hold the key for >2s • Switch off the display illumination: Press and hold the key for >2s
	<p>Change/navigate the display screen.</p>
	<ul style="list-style-type: none"> • Switches to the measurement view • Back to the menu • Switch on the instrument: Press and hold the key for > 1 s • Switch off the instrument: Press and hold the key for > 2 s

6 First steps

6.1 Charging the rechargeable battery

⚠ DANGER

- Do not charge the rechargeable battery in potentially explosive atmospheres!
- The device must only be recharged using the corresponding charger outside of a potentially explosive atmosphere in the ambient temperature range from 0 °C ... +35 °C.

⚠ WARNING

Risk of injury! The instrument may be damaged!

Deformation around the battery!

Regularly check the instrument for deformations around the battery. If you notice any deformation, the instrument must no longer be used. Switch it off to prevent physical injury or damage to the instrument. Dispose of the instrument properly (observe local regulations) or return it to Testo for disposal.



Only charge the battery using an original Testo mains unit.

The instrument indicates that the battery needs to be charged via a flashing battery symbol.

- 1 | Connect the instrument to the mains via the mains unit. To do this, insert the plug of the mains unit into the charging socket on the right side of the instrument.



The instrument can become very warm during charging and should not be held in your hand.

6.2 Inserting batteries





The exchangeable batteries are the backup power to continue working with the device when the integrated lithium battery is empty, e. g. for long-term measurements.

- ✓ The instrument is switched off.
- 1 Fold out the suspension hook, release the clip and remove the battery compartment lid.
- 2 Insert the batteries (scope of delivery, 3 x 1.5V, type AA Alkaline) into the battery compartment. Observe the polarity!
- 3 Attach and close the battery compartment (place).
- ▶ Switch the instrument on.



When not in use for a long period: Take out the batteries.

6.3 Switching the instrument on and off

Current status	Action	Function
Instrument off	Press  and hold down (> 1 s)	Instrument is switched on.
	When the measuring instrument is started for the first time, the setup wizard guides you through the following setting parameters step by step: - Language - testo Smart App	
Instrument on	Press  and hold down (> 2 s)	Instrument is switched off.



The instrument setup that is implemented can be adapted at any time in the **Settings** menu.

6.4 Setup wizard

When the **testo 558s** is started up for the first time and after the factory settings have been reset, the setup wizard is activated and guides you step-by-step through the following setup parameters.



The instrument setup that is implemented can be adapted at any time in the **Settings** menu.



As an alternative to the device buttons, the menus and buttons can also be selected or activated by tapping directly on the touch display.

Language selection and QR code

- ✓ Instrument is switched on and the initialization phase has been completed.

- 1 Select language: Press [**▲**] / [**▼**] and [**Menu/Enter**] to confirm.



Selecting the language activates the appropriate presetting of the units of measurement



Language

English (UK) ✓

English (US)

Deutsch

Dansk

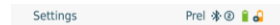

For increased functionality please download the testo smart app.



Back

Done

- 2 Take a photo of the QR code of the testo Smart App and press [**Menu/Enter**] to confirm.

- The measurement menu is displayed.

7 Using the product

7.1 Preparing for measurement

7.1.1 Operating the valve positioners

With respect to the refrigerant path, the digital manifold behaves just like a conventional four-way manifold: The passages are opened by opening the valves. The applied pressure is measured with the valves closed and the valves opened.

- Open the valve: Turn valve positioner anticlockwise.
- Close the valve: Turn valve positioner clockwise.

⚠ WARNING

Valve positioner tightened too tightly.

- Damage to the PTFE seal (1).
- Mechanical deformation of the valve piston (2) leading to the PTFE seal (1) falling out.
- Damage to the thread of the threaded spindle (3) and the valve screw (4).

Broken valve knob (5).

Only tighten the valve positioner hand-tight.
Do not use any tools to tighten the valve positioners.



7.1.2 Automatic mode

The manifold automatically detects the pressure difference between the low-pressure and high-pressure sides. If the measured pressure on the low pressure side is 1 bar higher than on the high pressure side, a dialogue appears and the display can be changed accordingly. If “yes” is selected, the low pressure moves from left to right and the high pressure moves from right to left.

This mode is particularly suitable for air conditioning systems that provide cooling and heating.

7.2 Measuring mode

WARNING

Risk of injury caused by refrigerant that is under high pressure, hot, cold, or toxic!

- > Wear protective goggles and safety gloves.
- > Before applying pressure to the measuring instrument: Always fasten the measuring instrument on the suspension hook to prevent it from falling (danger of breakage).
- > Before each measurement, check the refrigerant hoses are intact and connected properly. Do not use any tools to connect the hoses; only tighten hoses hand-tight (max. torque 5.0 Nm/3.7 ft*lb).
- > Comply with the permissible measuring range (-1 to 60 bar/-14.7 to 870 psi). Pay particular attention to this in systems with R744 refrigerant, since these are frequently operated at higher pressures!

7.2.1 Refrigeration

The **Refrigeration** application is used to determine the following system measuring values:

- High pressure
- Low pressure
- Refrigerant evaporating temperature
- Refrigerant condensation temperature
- Temperature of suction line
- Temperature of liquid line
- Superheating
- Subcooling



An NTC temperature probe (accessory) must be connected for measuring the pipe temperature and for automatic calculation of superheating and subcooling.

These can be fixed cable temperature probes or Testo Smart Probes (e.g. **testo 115i**).



Before each measurement, check that the refrigerant hoses are in flawless condition.



Before each measurement, zero the pressure sensors. All connections must be pressureless (ambient pressure). Press the **[▲] (P=O)** key for 2 seconds to zero the sensors.



As an alternative to the device buttons, the menus and buttons can also be selected or activated by tapping directly on the touch display.

- ✓ The instrument is switched on and the measurement menu is displayed.
- ✓ All connections must be pressureless (ambient pressure).

1 Press **[Menu/Enter]** to confirm.

- ▶ The main menu is displayed.

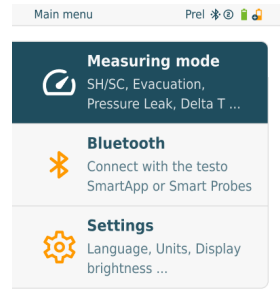

2 Press **[Menu/Enter]** to confirm.

3 Select **Refrigeration** and press **[Menu/Enter]** to confirm.

- ▶ The measurement view is displayed.

Tapping on a displayed measured value opens a graphical view in which the last 30 minutes of the measured value can be viewed. A maximum of two values can be displayed graphically at the same time.

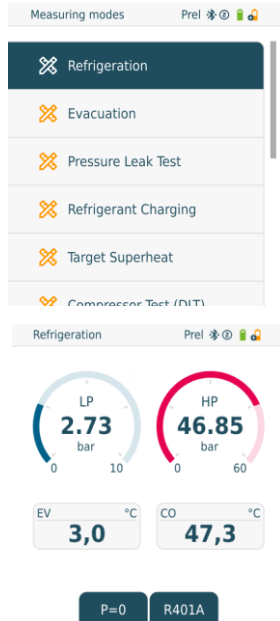

- 4 | Connect the refrigerant hoses.
- 4.1 | Close the valve positioners.
- 4.2 | Connect the refrigerant hoses for low-pressure side (blue) and high-pressure side (red) to the measuring instrument.
- 4.3 | Connect the refrigerant hoses to the system.
- 5 | Connect **testo 115i** or fixed cable probes.
- 6 | Set refrigerant.
- 6.1 | Press the key [▼] (Rxx) (refrigerant number according to ISO 817).

▶ The refrigerant menu opens and the current refrigerant is highlighted.

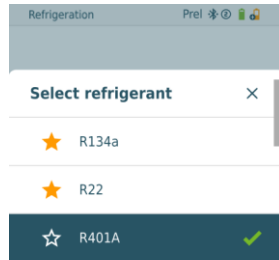

- 6.2 | Setting the refrigerant: Press [▲] or [▼] to select the refrigerant and press [Menu/Enter] to confirm.

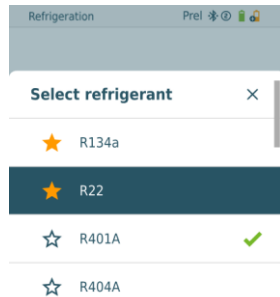

You have the option of setting up to 10 favorite refrigerants on your device and in the app. These will then appear at the top of the refrigerant list. In the refrigerant list, you can select the refrigerant as a favorite by clicking on the star.

▶ The newly set refrigerant is displayed in the refrigerant list.

7 Press the [**▲**] (**P=0**) key for 2 seconds to zero the sensors.

▶ Zeroing takes place.

8 Pressurize the measuring instrument.

▶ The measurement starts automatically.

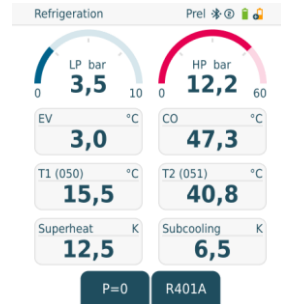

▶ Measurement results are displayed:

- Low/high pressure
- Condensation and evaporation temperature
- Suction and liquid line temperature
- Superheating and subcooling



With zeotropic refrigerants, the evaporation temperature to/Ev is displayed after complete evaporation/the condensation temperature tc/Co is displayed after complete condensation.

The measured temperature must be assigned to the superheating or subcooling side ($t_{oh} <--> t_{cu}$). Dependent on this assignment, the display will show $t_{oh}/T1$ resp. $\Delta t_{oh}/SH$ or $t_{cu}/T2$ resp. $\Delta t_{cu}/SC$, depending on the selected display.



Reading and display illumination flash:

- 1 bar/14.5 psi before reaching critical refrigerant pressure
- When max. permissible pressure of 60 bar/870 psi is exceeded.



All values can be saved and sent in the app. The data can also be transferred between the app and the testo DataControl software.

7.2.2 Evacuation

Via the **Evacuation** application, foreign gases and moisture can be removed from the refrigeration circuit.



The **testo 552i** is recommended for carrying out the measurement. The measurement is also possible without the **testo 552i**, with **testo 558s**. However, this is not advisable due to insufficient accuracy.

- ✓ The instrument is switched on and the measurement menu is displayed.
 - ✓ **Bluetooth®** is enabled.
 - ✓ Hoses are connected.
- 1 Press **[Menu/Enter]**.

- 2 Press **[▲] / [▼]** to select **Measuring Mode** and press **[Menu/Enter]** to confirm.

- ▶ The **Measuring Mode** menu is displayed.

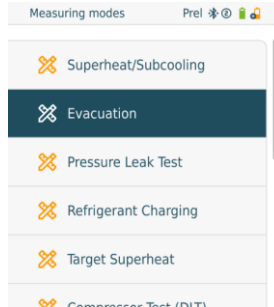
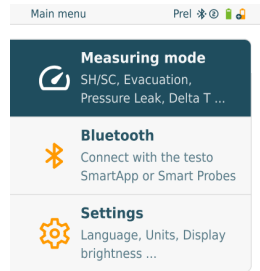

- 3 Press **[▲] / [▼]** to select **Evacuation** and press **[Menu/Enter]** to confirm.

- ▶ The **Configure Target Lines** menu is displayed.

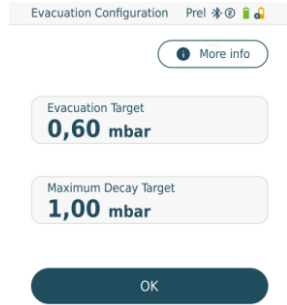

As an alternative to the method described here using the operating buttons, the values can also be selected via the touch display and entered using a keypad.

- 4 Adjust the **Target Line** value
 - 4.1 Press the [▲] key to activate the **Evacuation Target** field.
 - 4.2 Press [▲] / [▼] to set the value.
 - 4.3 Press [Menu/Enter] to confirm.
 - 5 Adjust the **Maximum Decay Target** value on the same way.
 - 6 Confirm the entries in steps 4 and 5:
Press [▼] to select **OK** and press [Menu/Enter] to confirm.
- ▶ A connection is established with available Bluetooth® probes.
 - ▶ **testo 552i** is switched on and connected automatically.

- ▶ The **Evacuation** measurement menu is displayed.



- 7 Start measurement: Press the [▼] (**Start**) key.

- Once the measuring range 0 to 20,000 microns / 0 to 26.66 mbar is reached, the current vacuum value is shown on the instrument display. The instrument also displays the current ambient temperature, the water evaporation temperature which corresponds to the vacuum reading, and the delta between these two temperatures.



- 8 End measurement: Press the **[▼] (Stop)** key.
 - ▶ The measurement result is displayed.



Press the **[▲] New** key to reset the determined values. If necessary, a test can also be started again.

- 9 Press **[Menu/Enter]** to return to the main menu.

7.2.3 Pressure Leak Test

The temperature compensated leakage test can be used to check the leak tightness of systems. For this purpose both the system pressure and the ambient temperature are measured over a defined period of time.



To this end, a temperature probe that measures the ambient temperature or a Smart Probe for measuring the air temperature can be connected. As a result, information is provided about the temperature-compensated differential pressure and about the temperature at the beginning/end of the test. Due to the temperature compensation, the actual pressure drop is displayed as delta P. If no temperature probe is connected, you may also perform the tightness test without temperature compensation.



Surface temperature probes (e.g. **testo 115i**) can also be used for the temperature-compensated leakage testing, but must not be used to measure surface temperature. They must be positioned as far as possible to measure the air temperature. If a surface probe is used, in the **Settings** menu of the **testo 558s**, the **Auto Tfac (Temperature compensation factor)** must be switched off, see section 8.3.4.



The **testo 558s** manifold is used to carry out the measurement.

- ✓ The instrument is switched on and the measurement menu is displayed.
- ✓ Hoses are connected.
- 1 Press **[Menu/Enter]**.
- 2 Press **[▲] / [▼]** to select **Measuring Mode** and press **[Menu/Enter]** to confirm.

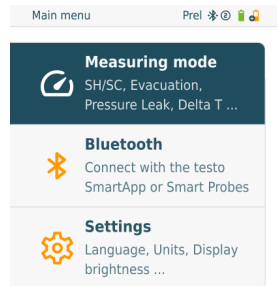

- The **Measuring Mode** menu is displayed.

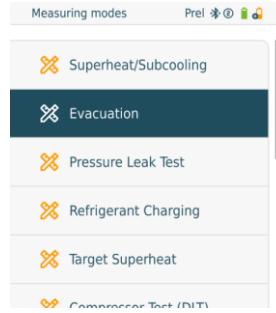

- 3 Press [**▲**] / [**▼**] to select **Pressure Leak Test** and press [**Menu/Enter**] to confirm.

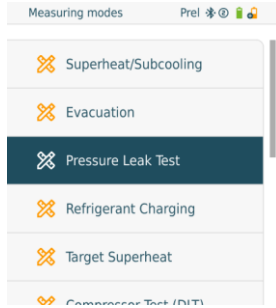

- For the temperature-compensated leak test, a connection is established with available Bluetooth® probes. If cable probes are connected to the instrument, they are prioritized for the compensation. Please note that only air probes are ideal for temperature-compensated leakage testing.
- **testo 915i / testo 605i** is switched on and automatically connected. Other temperature probes compatible with **testo 558s** can be connected.
- The **Pressure Leak Test** menu is displayed.



T Comp is shown on the display if a compatible probe is connected via Bluetooth® or cable. The temperature compensation is used for the measurement result.

- 4 Press the [**▼**] (**Start**) key.
 - The leakage test is carried out.
- 5 Press the [**▼**] (**Stop**) key.
 - The leakage test is terminated.

- The measurement result is displayed.

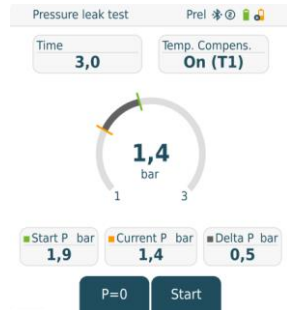

Press the [**▲**] **New** key to reset the determined values. If necessary, a test can also be started again.



The measurement result can be displayed graphically on the manifold as well as in the app.

-
- 6 Press [**Menu/Enter**] to return to the main menu.

7.2.4 Target Superheat

This feature makes it possible to connect the **testo 558s** manifold to two additional **testo 605i** Smart Probes in order to calculate the target superheat. This application can only be used for split air conditioning systems/heat pumps with a fixed expansion valve. The two connected **testo 605i** Smart Probes determine the **ODDB** and **RAWB** values. The target superheat value appears on the display as a result.



The following are used for the measurement:

- **testo 115i** (clamp thermometer) or
- fixed cable probes
- **testo 605i**
in practice.



Alternatively, the values can be configured manually.



Before each measurement, check that the refrigerant hoses are in flawless condition.



Before each measurement, zero the pressure sensors.

- ✓ The instrument is switched on and the measurement menu is displayed.
 - ✓ All connections must be pressureless (ambient pressure).
 - ✓ **Bluetooth®** is enabled.
- 1 Press **[Menu/Enter]**.
 - 2 Press **[▲] / [▼]** to select **Measuring Mode** and press **[Menu/Enter]** to confirm.

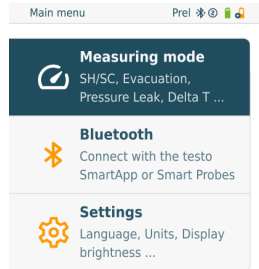

- ▶ The **Measuring Mode** menu is displayed.

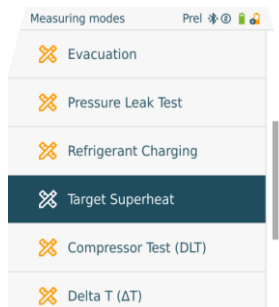

- 3 Press **[▲]** / **[▼]** to select **Target Superheat** and press **[Menu/Enter]** to confirm.

- ▶ The **Configure Target Superheat** menu is displayed.

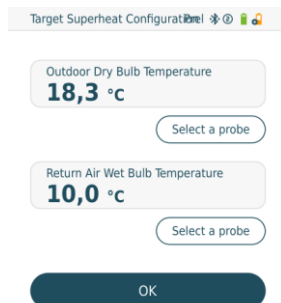

The values can either be configured manually via **Manual Input** or recorded by the **testo 605i** via **Smart Probe**. When a **Smart Probe** is selected, available **testo 605i** instruments are displayed for the connection.

- 4 Adjust values for **Outdoor Dry Bulb Temp.**
 - 4.1 Press the **[▲]** key and in the **Outdoor Dry Bulb Temp.** field, select **Manual Input**.
 - 4.2 Press **[Menu/Enter]** to confirm.
 - ▶ The field is activated.
 - 4.3 Press **[▲]** / **[▼]** to set the value.
 - 4.4 Press **[Menu/Enter]** to confirm.
- 5 Adjust the **Return Air Wet Bulb Temp.** value

- 5.1 Press the [▲] / [▼] key and in the **Return Air Wet Bulb Temp.** field, select **Manual Input**.

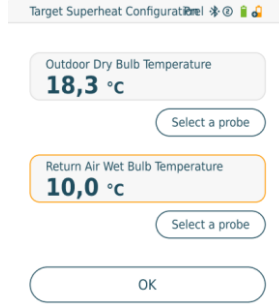

- 5.2 Press [Menu/Enter] to confirm.

▶ The field is activated.

- 5.3 Press [▲] / [▼] to set the value.

- 5.4 Press [Menu/Enter] to confirm..

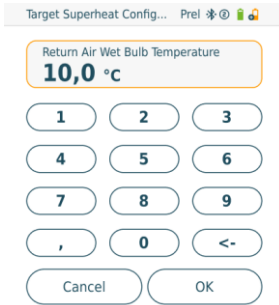

- 6 Confirm the entries in steps 4 and 5: Press [▼] to select **Okay** and press [Menu/Enter] to confirm.

▶ The **Target Superheat** measurement menu is displayed.



- 7 Connect the refrigerant hoses.

- 7.1 Close the valve positioners.

- 7.2 Connect the refrigerant hoses for low-pressure side (blue) and high-pressure side (red) to the measuring instrument.

- 7.3 Connect the refrigerant hoses to the system.

- 8 Connect **testo 115i**/fixed cable probes.

9 Set refrigerant.

9.1 Press the key [▼] (Rxx) (refrigerant number according to ISO 817).

- ▶ The refrigerant menu opens and the current refrigerant is highlighted.

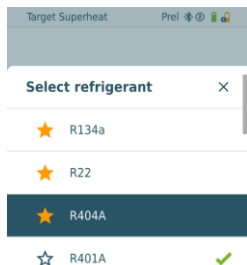

9.2 Setting the refrigerant: Press [▲] or [▼] to select the refrigerant and press [Menu/Enter] to confirm.

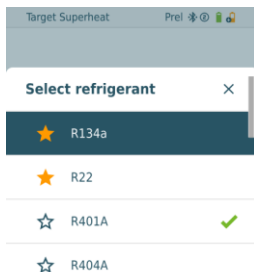

- ▶ The newly set refrigerant is displayed in the refrigerant list.

10 Press the [▲] (P=O) key for 2 seconds to zero the sensors.

- ▶ Zeroing takes place.

11 Pressurize the measuring instrument.

- ▶ The measurement starts automatically.

- ▶ Measurement results are displayed:

- Low/high pressure
- Condensation and evaporation temperature
- Suction and liquid line temperature
- Superheating and subcooling
- Target superheat TSH

7.2.5 Compressor Test (DLT)

For this mode, 3 temperature probes are used. In addition to the conventional temperature sensors for superheating and subcooling, an additional temperature probe must be connected via Bluetooth.



The testo 115i (clamp thermometer) or fixed cable probes are used to carry out the measurement.



Before each measurement, check that the refrigerant hoses are in flawless condition.



Before each measurement, zero the pressure sensors.



The instrument is switched on and the measurement menu is displayed.

1

Press **[Menu/Enter]**.

2

Press **[▲] / [▼]** to select **Measuring Mode** and press **[Menu/Enter]** to confirm.

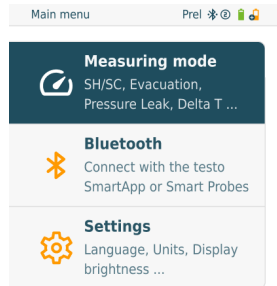

The **Measuring Mode** menu is displayed.

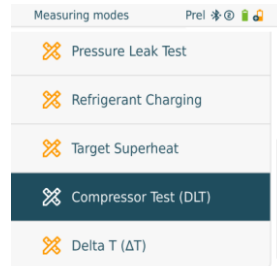

3

Press **[▲] / [▼]** to select **Compressor Test (DLT)** and press **[Menu/Enter]** to confirm.

- ▶ The measurement menu is displayed.
The DLT temperature is shown on the display.

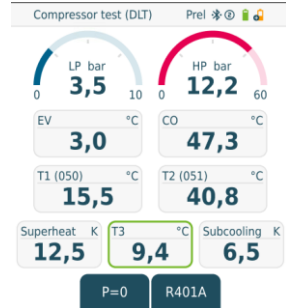

- 4 Connect the refrigerant hoses.
- 4.1 Close the valve positioners.
- 4.2 Connect the refrigerant hoses for low-pressure side (blue) and high-pressure side (red) to the measuring instrument.
- 4.3 Connect the refrigerant hoses to the system.
- 5 Connect 2 x **testo 115i** or 2 x fixed cable probes and third temperature probe to the compressor outlet.
- 6 Set refrigerant.
- 6.1 Press the key [▼] (Rxx) (refrigerant number according to ISO 817).

- ▶ The refrigerant menu opens and the current refrigerant is highlighted.

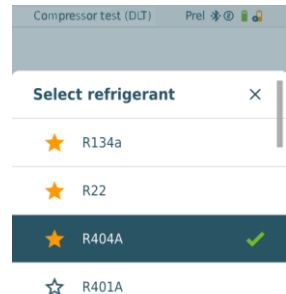

- 6.2 Setting the refrigerant: Press [**▲**] or [**▼**] to select the refrigerant and press [**Menu/Enter**] to confirm.

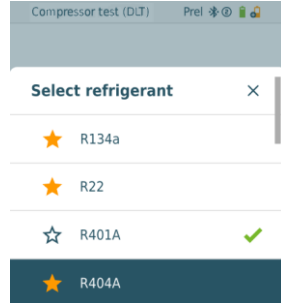

- ▶ The newly set refrigerant is displayed in the refrigerant list.
- 7 Press the [**▲**] (**P=O**) key for 2 seconds to carry out zeroing.
- ▶ Zeroing takes place.
- 8 Pressurize the measuring instrument.
- ▶ The measurement starts automatically.
 - ▶ The measurement result is displayed.
- 9 Press [**Menu/Enter**] to return to the main menu.

7.2.6 Delta T

Temperature 1 and temperature 2 are measured. The difference is shown on the display as the delta temperature.



Two **testo 115i** (clamp thermometers) or fixed cable probes are used to carry out the measurement.

- ✓ The instrument is switched on and the measurement menu is displayed.
 - ✓ The steps described in the **Preparing for measurement** section have been followed/carried out.
 - ✓ **testo 115i** is switched on.
- 1 Place the **testo 115i** at the measuring points.
 - 2 Press [**Menu/Enter**].

- 3 Press [**▲**] / [**▼**] to select **Measuring Mode** and press [**Menu/Enter**] to confirm.

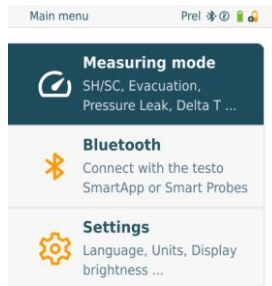

- ▶ The **Measuring Mode** menu is displayed.

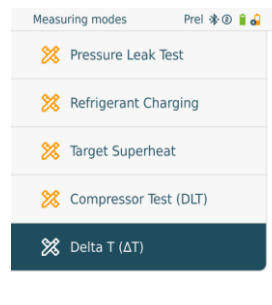

- 4 Press [**▲**] / [**▼**] to select **Delta T** and press [**Menu/Enter**] to confirm.

- ▶ The measurement result is displayed.

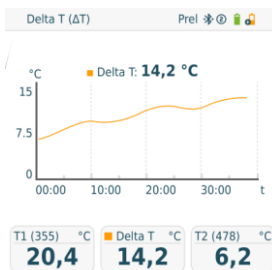

- 5 Press [**Menu/Enter**] to return to the main menu.

7.3 Performing long time measurement



The usage of this function requires a one-off, chargeable activation via the testo Smart App.

With its integrated logging function the device can be left on the system and logging can be done without being on site.

This allows an intelligent error analysis in the testo Smart App.

The logging is possible for following applications:

- Refrigeration
- Evacuation
- Pressure leak test
- Compressor test



The logging can only be started, stopped and saved from the connected testo Smart App.



When a long term measurement is done with the testo 770-3 Clamp Meter, the battery status of the testo 770-3 can't be shown or considered in the testo 558s. The technician has to make sure, that the testo 770-3 has enough battery capacity for the planned logging time.



While the device is in logging mode, all functions are blocked.

Only the live view is available, which means the current values are shown in the screen like usual. For example in refrigeration mode all 8 measured values are shown (9 measured values if connected with testo 770-3).

When pressing any button a corresponding information message is shown.

Refrigeration **Logging** Prel * @

Remaining time:

01:59:47

Start time: **2024-01-29 11:33:29**

Duration: **0 d 02 Hr. 00 Min.**

Measuring cycle: **1 sec.**

Important info: The logging can only be stopped and saved from the testo Smart App.

Probes

Live view

7.4 Refrigerant charging

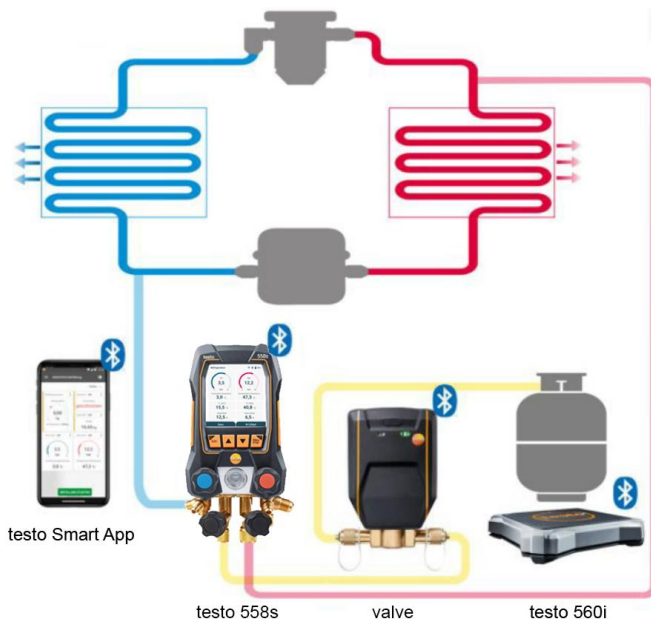

In combination with **testo 560i** and the **testo Smart Valve** the manifold **testo 558s** offers multiple functions to charge refrigerant systems.

7.4.1 Manual charging via weight

This function enables a refrigerant circuit to be charged manually via weight using the **testo 560i** in combination with the app or **testo 558s** manifold.

By manually opening and closing the refrigerant bottle valve, the system is charged with refrigerant until the target value (weight/superheating/subcooling) is reached.



Displaying the current target values superheating/subcooling is only possible in combination with **testo 115i** smart probes.



When using the manifold, the app is in second-screen mode. All settings must be made on the manifold.



Before each measurement, check that the refrigerant hoses are in flawless condition and applied to all ports tight to prevent leaks.



The system must be supervised by a competent person throughout the entire process.

- ✓ | testo 560i is connected via Bluetooth to the testo Smart App or the testo 558s manifold.
- ✓ | testo 560i is integrated into the refrigerant circuit.
- 1 | Select the required refrigerant on the manifold/app and press **[Menu/Enter]** to confirm.
- 1.1 | If necessary, zero sensor on manifold/app [P = 0].
- 1.2 | If necessary, zero testo 560i on manifold/app [W = 0].

- 2 Open connected valve(s) manually and add refrigerant to the system until the required value is reached.



Charging manually means the user will need to control the charge by opening and closing valves with a manifold or other valves.

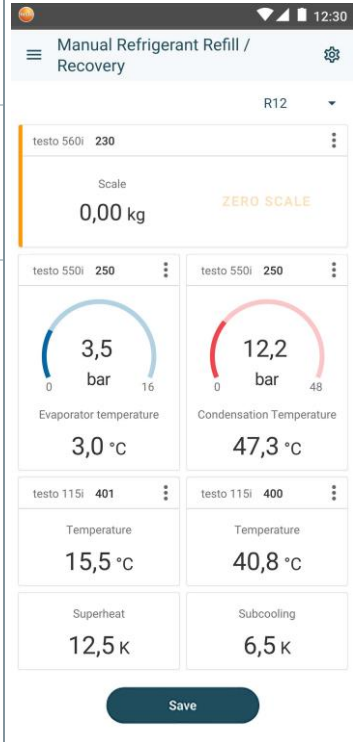

- ▶ Added refrigerant is displayed in g/kg increments on the manifold/app.

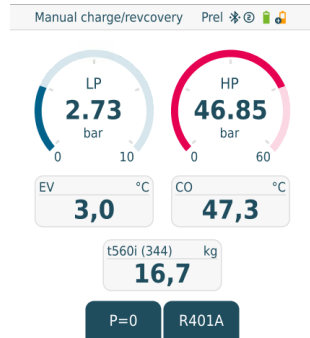

7.4.2 Automatic charging by target weight

This function enables the system to be charged automatically with an input target weight using the **testo 560i** scale and the **testo Smart Valve** in combination with the app or the **testo 558s** manifold.



When using the manifold, the app is in second-screen mode. All settings must be made on the manifold.



Before each measurement, check that the refrigerant hoses are in flawless condition and applied to all ports tight to prevent leaks.



The system must be supervised by a competent person throughout the entire process.

- ✓ testo 560i and testo Smart Valve are connected via Bluetooth to the testo Smart App or the testo 558s manifold.
- ✓ testo 560i and testo Smart Valve are integrated into the refrigerant circuit.
- 1 Select the required refrigerant on the manifold/app and press **[Menu/Enter]** to confirm.
- 1.1 If necessary, zero sensor on manifold/app [P = 0].
- 2 In the manifold/app, select the proper refrigerant and select if pulsed charging is desired (on/off).



Pulsed charging means that the valve opens and closes several times and the desired amount is thus filled in several small steps.

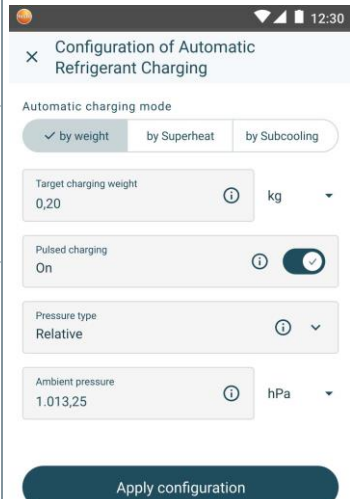

- 3 Enter Target Weight by selecting manual input and hit **[START CHARGE]** to start the process.

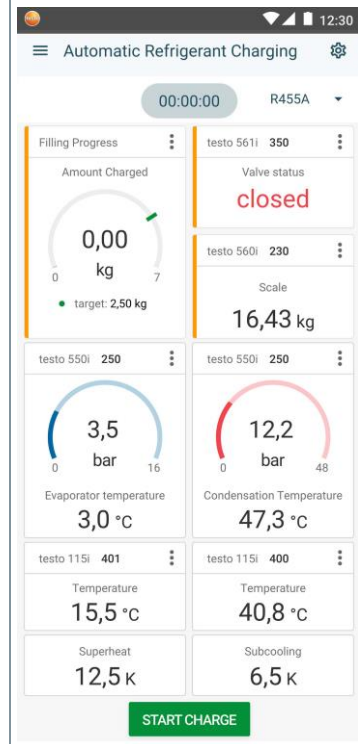
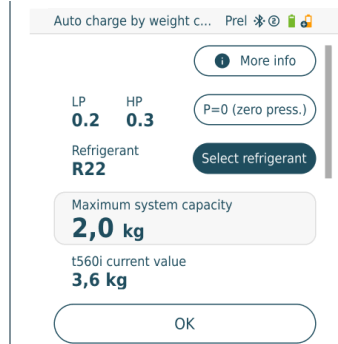

▶ The valve opens and attempts to fill with the set charge quantity.

No pulsating charging takes place.



- ▶ Added refrigerant is displayed in g/kg increments on the manifold/app.

- 4 Once charging is finished, the process can be repeated [**NEW**] or another mode for charging [**OPTIMIZE**] can be selected.

Auto charge by weight c... Prel   

Refrigerant **R22**

Maximum system capacity
2,0 kg

t560i current value
3,6 kg

Superheat Target
2,8 K

Automatic refrigerant charging 

00:04:32 

Charging progress

Charged weight

0,6 kg

testo Valve • 888 

Connected

testo 550c: testo 560i • 999 

Optimize the charging process

You can further optimize the charging process by adding an additional amount of refrigerant or using a different automatic charging method.

add weight Charge by Superheat Charge by Subcooling

Amount Unit

7.4.3 Automatic charging by subcooling

This function enables a refrigerant circuit to be charged via the target subcooling value using the **testo 560i** scale and the **testo Smart Valve** in combination with the app or **testo 558s** manifold.

For this, the current subcooling value is determined. Based on this information, a target subcooling value can be entered. The system is filled automatically until the target value is reached.



Displaying the target subcooling value is only possible in combination with **testo 115i** smart probes.



The appropriate maximum charge value for a system must be entered in the **[Max charge]** field on the manifold/app.



The appropriate subcooling target value for a system must be entered on the manifold/app.



When using the manifold, the app is in second-screen mode. All settings must be made on the manifold.



Based on the specified system size the algorithm creates a maximum weight to be filled. When this maximum weight is reached, automatic filling is paused and must be restarted. This prevents overfilling or incorrect filling.



Before each measurement, check that the refrigerant hoses are in flawless condition.



The system must be supervised by a competent person throughout the entire process.

- ✓ testo 560i and testo Smart Valve are connected via Bluetooth to the testo Smart App or the testo 558s manifold.
- ✓ testo 560i and testo Smart Valve are integrated into the refrigerant circuit.
- ✓ Two testo 115i are attached and connected via Bluetooth to the testo Smart App or the testo 558s manifold.
- 1 Select the required refrigerant on the manifold/app and press **[Menu/Enter]** to confirm.
- 1.1 If necessary, zero sensor on manifold/app [P = 0].

- 2 In the manifold/app, select the proper refrigerant and enter the maximum system charge.

The screenshot shows a mobile application interface for configuring automatic refrigerant charging. At the top, there is a status bar with a signal strength icon, Wi-Fi icon, battery icon, and the time 12:30. Below the status bar is a navigation bar with a back arrow and the title "Configuration of Automatic Refrigerant Charging". The main content area is titled "Automatic charging mode" and features three selectable options: "by weight", "by Superheat", and "by Subcooling". The "by Subcooling" option is currently selected, indicated by a checkmark. Below the mode selection, there are four input fields, each with an information icon (i) on the right:

- Subcooling target:** The value is 6,7 and the unit is K.
- System capacity:** The value is 1,00 and the unit is kg.
- Pressure type:** The value is Relative and the unit is indicated by a dropdown arrow.
- Ambient pressure:** The value is 1.013,25 and the unit is hPa.

At the bottom of the configuration screen is a large, dark blue button labeled "Apply configuration".

- 3 Set the required target subcooling value to be reached on the manifold/app and hit **[START CHARGE]** to start the process.

▶ The valve opens and attempts to reach the set subcooling by charging refrigerant.

- ▶ Added refrigerant is displayed in g/kg increments on the manifold/app.

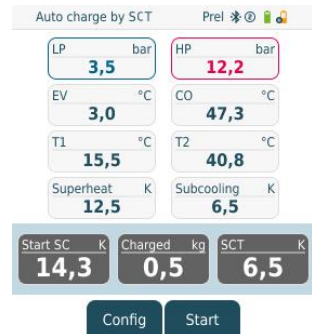
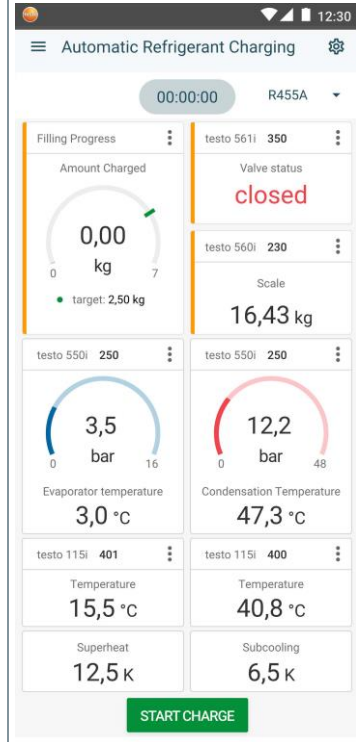

7.4.4 Automatic charging by superheat

This function enables a refrigerant circuit to be charged via the target superheat value using the **testo 560i** scale and the **testo Smart Valve** in combination with the app or **testo 558s** manifold.

For this, the current superheating value is determined. Based on this information, a target superheat value can be entered. The system is filled automatically until the target value is reached.



Displaying the target superheat value is only possible in combination with **testo 115i** smart probes.



The appropriate maximum charge value for a system must be entered in the **[Max charge]** field on the manifold/app.



The appropriate superheat target value for a system must be entered on the manifold/app or recorded by the **testo 605i** via **Live Tar. SH**.



Based on the specified system size the algorithm creates a maximum weight to be filled. When this maximum weight is reached, automatic filling is paused and must be restarted. This prevents overfilling or incorrect filling.



When using the manifold, the app is in second-screen mode. All settings must be made on the manifold.



Before each measurement, check that the refrigerant hoses are in flawless condition.



The system must be supervised by a competent person throughout the entire process.

- ✓ | testo 560i and testo Smart Valve are connected via Bluetooth to the testo Smart App or the testo 558s manifold.
- ✓ | testo 560i and testo Smart Valve are integrated into the refrigerant circuit.
- 1 | Select the required refrigerant on the manifold/app and press **[Menu/Enter]** to confirm.
- 1.1 | If necessary, zero sensor on manifold/app [P = 0].

- 2 In the manifold/app, select the proper refrigerant and enter the maximum system charge.

The screenshot shows a mobile application interface for configuring automatic refrigerant charging. At the top, there is a status bar with a signal strength icon, Wi-Fi icon, battery icon, and the time 12:30. Below the status bar is a header with a back arrow and the title "Configuration of Automatic Refrigerant Charging". The main content area is titled "Automatic charging mode" and contains three radio button options: "by weight", "by Superheat" (which is selected with a checkmark), and "by Subcooling". Below this is a toggle switch for "Charge by Live Target Superheat", which is currently turned "Off". There are four input fields, each with an information icon (i) on the right: "Superheat target" is set to "5,6" with a unit of "K"; "System capacity" is set to "1,00" with a unit of "kg" and a dropdown arrow; "Pressure type" is set to "Relative" with a dropdown arrow; and "Ambient pressure" is set to "1.013,25" with a unit of "hPa" and a dropdown arrow. At the bottom of the screen is a large, dark blue button labeled "Apply configuration".

- 3 Set the required target superheat value to be reached on the manifold/app and hit **[START CHARGE]** to start the process.

▶ The valve opens and attempts to reach the set superheat by charging refrigerant.

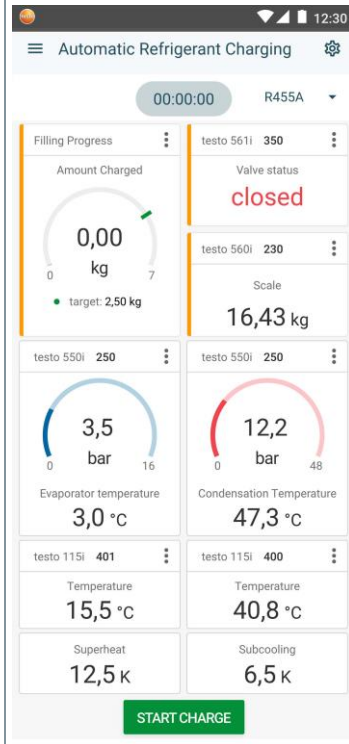

- ▶ Added refrigerant is displayed in g/kg increments on the manifold/app.



7.5 Bluetooth

The **testo 558s** has the option of establishing a Bluetooth® connection with wireless probes as well as a connection to the testo Smart App at the same time.



If the **testo 558s** is used with Smart Probes, they must be at least 20 cm apart.

7.5.1 Probes compatible with the instrument

Smart Probes

Order no.	Designation
0560 2115 02	testo 115i – clamp thermometer with smartphone operation
0560 2605 02	testo 605i – thermohygrometer with smartphone operation
0564 2552 01	testo 552i – vacuum Smart Probe
0563 4915	testo 915i – thermometer with flexible probe and smartphone operation

Clamp meter

Order no.	Designation
0590 7703	testo 770-3 – Clamp meter with Bluetooth®

NTC probes

Order no.	Designation
0613 1712	Robust air temperature probe (NTC)
0613 5505	Clamp probe (NTC) for temperature measurements on pipes (Ø 6-35 mm), 1.5 m fixed cable
0613 5506	Clamp probe (NTC) for temperature measurements on pipes (Ø 6-35 mm), 5 m fixed cable
0613 5507	2 x clamp probes (NTC) for temperature measurements on pipes (Ø 6-35 mm), 1.5 m fixed cable
0613 4611	Temperature probe with Velcro (NTC)
0613 5605	Pipe wrap probe (NTC), measuring range: -50 to +120 °C
0613 1912	Waterproof surface temperature probe (NTC) for flat surfaces, measuring range: -50 to +150 °C

7.5.2 Establishing a connection



To establish a connection via Bluetooth®, you need a tablet or smartphone with the Testo Smart App installed on it.

You can get the App for iOS instruments in the App Store or for Android instruments in the Play Store.

Compatibility:

Requires iOS 13.0 or later/Android 8.0 or later, requires Bluetooth® 4.0.



Once the connection between the app and the Testo manifold has been successfully established, the app is in second screen mode. This is indicated by a yellow frame in the app.

This means that all measurement data from the manifold is being mirrored on the app. The measurement can now be controlled from both instruments. It is possible to carry out the following actions:

- Start measurement
- Stop measurement
- Reset measurement
- Configure measurement
- Select refrigerant

7.5.3 Switching on/off

- ✓ The instrument is switched on and the measurement menu is displayed.
- 1 Press **[Menu/Enter]**.
 - 2 Press **[▲] / [▼]** to select **Bluetooth:** and press **[Menu/Enter]** to confirm.

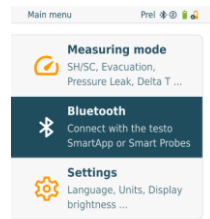

- ▶ The **Bluetooth** menu is displayed.

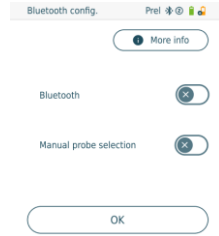

7.5.3.1 Switching on

- ✓ The Bluetooth menu is selected.

1 [Menu/Enter]

- ▶ In the On/Off switch icon,  is displayed.

- 2 Enable Bluetooth®: Press [▼] to activate the [Completed] button and press [Menu/Enter] to confirm.

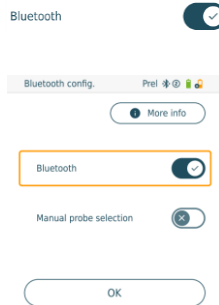

- ▶ When the Bluetooth® icon is shown on the display, Bluetooth is switched on.
- ▶ Bluetooth® automatically searches for and connects available probes.
- ▶ After opening the App, the instrument is automatically connected if it is within range. The instrument does not have to be connected to the smartphone/tablet via settings beforehand.

7.5.3.2 Switching off

- ✓ The Bluetooth® menu is activated.

1 [Menu/Enter]

- ▶ In the On/Off switch icon,  is displayed.



- 3 Disable Bluetooth®: Press [▼] to activate the [Completed] button and press [Menu/Enter] to confirm.

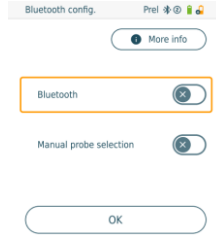

- ▶ When the Bluetooth® icon is not shown on the display, Bluetooth® is switched off.

7.5.3.3 Manual probe selection

If this menu is activated, it appears before a measurement.

- ✓ The Bluetooth® menu is activated (in the On/Off switch icon,  is displayed).

- 1 Press [▼] to select **Manual probe selection**.

Enable function: Via [Menu/Enter], set the switch to [ON].



An info window with the available probes appears before each measurement to be carried out. The information must be confirmed by pressing [Menu/Enter]/[Okay].

Disable function: Via [Menu/Enter], set the switch to [OFF].





If the advanced Bluetooth® settings are switched off, the instrument automatically connects to the first compatible Smart Probe.

- 2 Press [▼] to click on the [Completed] button and press [Menu/Enter] to confirm.



In the Bluetooth®  menu, you will obtain further information.

Display	Explanation
 flashes	There is no Bluetooth® connection, or a potential connection is being searched for.
 is permanently displayed	There is a Bluetooth® connection, the number of connected Bluetooth® probes is displayed next to it.
 is not displayed	Bluetooth® is disabled.

7.6 Settings

- ✓ The instrument is switched on and the measurement menu is displayed.

1 Press **[Menu/Enter]**.

2 Select **Settings**: Press **[▼]** and then **[Menu/Enter]** to confirm.

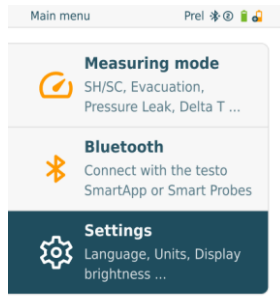

- ▶ The **Settings** menu is displayed.

Available settings:

- **Screen Auto Off**
- **Auto Tfac (Temperature compensation factor)**
- **Units**
- **Language**
- **Setup Wizard**
- **Restore factory settings**
- **Instrument information**

7.6.1 Screen Auto Off

You can manage the energy consumption for your instrument yourself.

- ✓ The **Settings** menu is activated.

- 1 Press [**▲**] / [**▼**] to select [**Screen Auto OFF**] and press [**Menu/Enter**] to confirm.

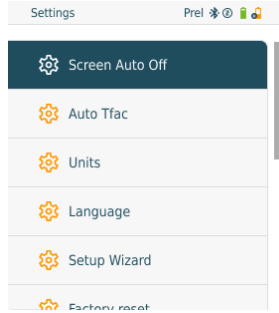

▶ Menu properties are displayed.

- 2 Select using [**▲**] / [**▼**]
 - On: The instrument automatically switches off after 30 minutes of inactivity.

i The instrument switches off automatically if no pressure is measured and no key was pressed within 10 minutes. As long as pressure is present, the instrument remains on.

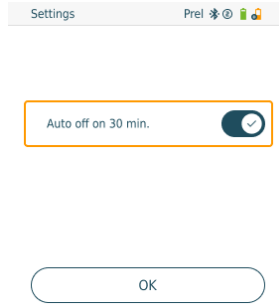

- Off: Continuous operation

- 3 Press [**Menu/Enter**] to confirm selection.

- 4 Press [**ESC**]: 1x main menu view, 2 x measurement menu view.

i Unsaved readings are lost when the measuring instrument is switched off.

7.6.2 Auto Tfac (Temperature compensation factor)

A surface compensation factor has been set in the measuring instrument to reduce the measuring errors in the main field of applications. This reduces measuring errors when using surface temperature probes.



Surface temperature probe

An NTC temperature probe (accessory) must be connected for measuring the pipe temperature and for automatic calculation of superheating and subcooling.

- ✓ The **Settings** menu is activated.

- 1 Select **Auto Tfac** and press **[Menu/Enter]** to confirm.

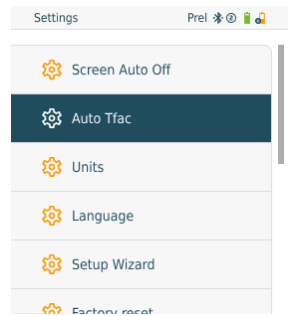

- ▶ Menu properties are displayed.

- 2 Press **[▲]** / **[▼]** to select **On/Off** and press **[Menu/Enter]** to confirm.

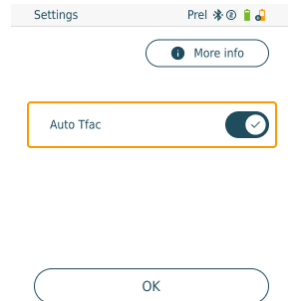

Press **[▲]** / **[▼]** to select the question mark icon and **[Menu/Enter]** to open. You will obtain further information on temperature compensation.

- 3 Press **[ESC]**: 1x main menu view, 2 x measurement menu view

7.6.3 Units

- ✓ The **Settings** menu is activated.

- 1 Press [**▲**] / [**▼**] to select [**Units**] and press [**Menu/Enter**] to confirm.

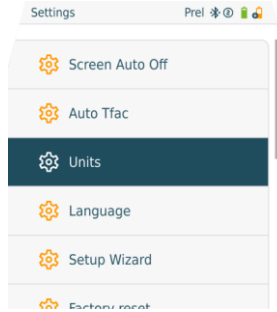

- ▶ Menu properties are displayed.

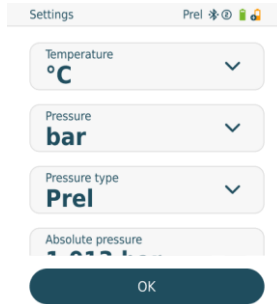

Adjustable units

Measurement parameter	Unit	Description
Temperature	°C, °F	Set unit for temperature.
Pressure	psi, kPa, MPa, bar, inHg	Set unit for pressure.
Pressure mode	Prel, Pabs	Depending on the chosen unit for pressure: Change between absolute and relative pressure displays.
Absolute pressure	Pabs	Set the current absolute pressure (current air pressure values for your region can be obtained, for example, from the local weather service or on the Internet).
Vacuum pressure	Micron, mbar, Torr, mTorr	

Measurement parameter	Unit	Description
	inH2O, in Hg, hPa, Pa	
Weight	kg, g, lb, oz	

- Press **[ESC]**: 1 x **Units** menu, 2 x main menu view, 3 x measurement menu view.

7.6.4 Language

- ✓ The **Settings** menu is activated.

- Press **[▲]** / **[▼]** to select **[Language]** and press **[Menu/Enter]** to confirm.

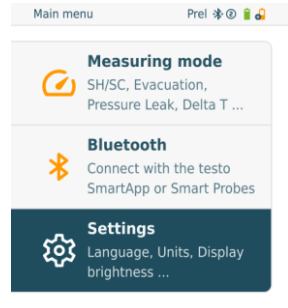

- ▶ Menu properties are displayed.

- Select language: Press **[▲]** / **[▼]** and **[Menu/Enter]** to confirm.

 Selecting the language activates the appropriate presetting of the units of measurement.

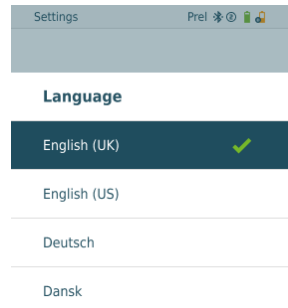

- Press **[ESC]**: 1 x **Units** menu, 2 x main menu view, 3 x measurement menu view.

7.6.5 Setup Wizard

- ✓ The **Settings** menu is activated.
- 1 Press [**▲**] / [**▼**] to select [**Setup Wizard**] and press [**Menu/Enter**] to confirm.

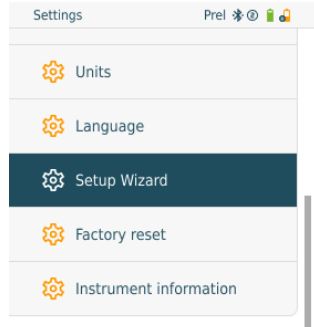

- ▶ Language selection opens.

- 2 Press [**▲**] / [**▼**] to select the language.

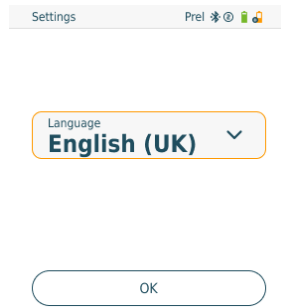

- ▶ The units for the respective country are set automatically.

- ▶ Barcode is displayed and the app can be downloaded from the respective app store.



7.6.6 Restore factory settings

The instrument is reset to the factory settings.

- ✓ The **Settings** menu is activated.
- 1 Press **[▲]** / **[▼]** to select **[Factory Reset]** and press **[Menu/Enter]** to confirm.
- ▶ Menu properties are displayed.
- 2 Start **[Factory Reset]**: Press **[▲]** / **[▼]** to select **[Do a factory reset]** and press **[Menu/ESC]** to confirm.
 Press **[Back]** to quit the process.
- ▶ **[Factory Reset]** is carried out.
- 3 See **Setup Wizard**.

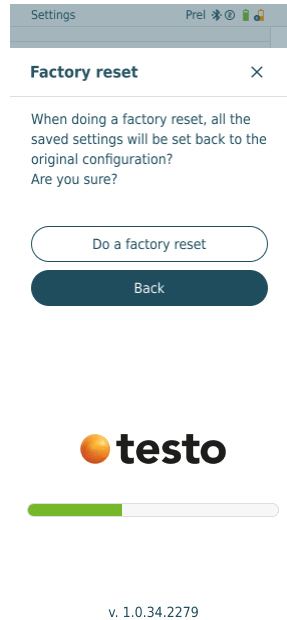
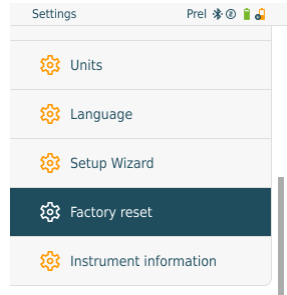

7.6.7 Device Info

- ✓ The **Settings** menu is activated.

- 1 Press [**▲**] / [**▼**] to select [**Instrument information**] and press [**Menu/Enter**] to confirm.

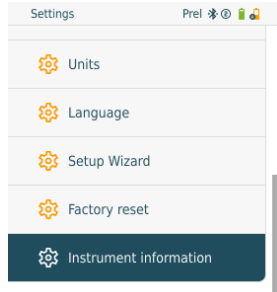

- ▶ The **Instrument information** menu is displayed.

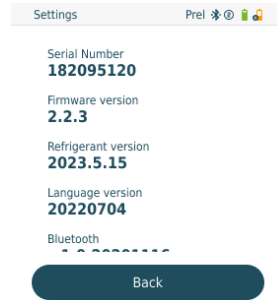



- 2 Press [**ESC**]: 1 x **Units** menu, 2 x main menu view, 3 x measurement menu view.

8 Smart App

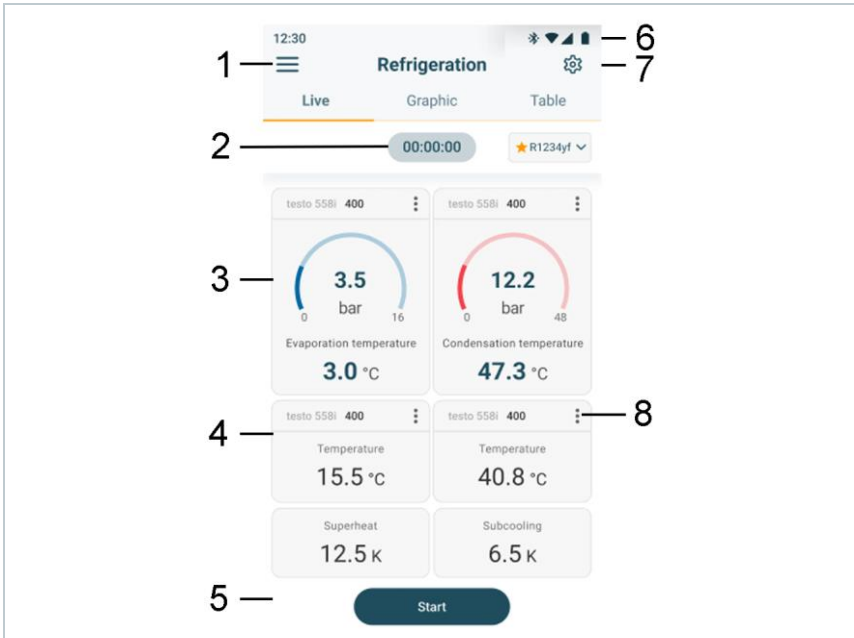
8.1 App – user interface







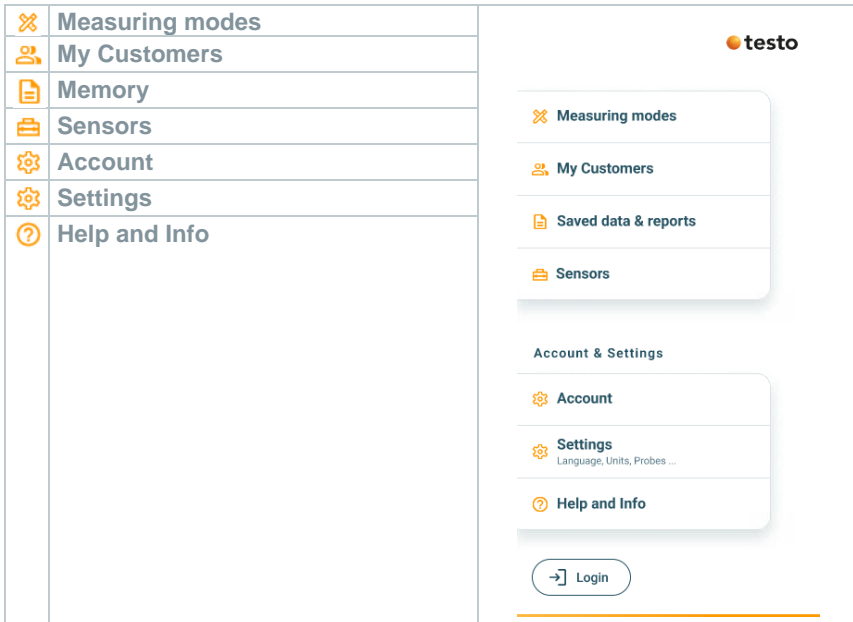

1		Open main menu
2		Display of the measurement period
3		Display of calculated measurement results
4		Reading for each probe
5		Can be controlled with different function keys
6		Instrument status bar
7		Configuration
8		Edit reading display

8.2 Main menu

The **Main menu** can be accessed via the  icon at top left. To exit the main menu, select a menu or right-click on the guided menu. The last screen displayed is shown.



Additional icons:

	One level back		Deleting
	Exit view		Further information
	Share measurement data/reports		Display report
	Search		Edit
	Favourite		

8.3 Measurement menu

The testo Smart App has for testo 558s permanently installed measurement programs. These enable the user to carry out convenient configuration and implementation of specific measuring tasks.

The testo Smart App offers the following **Measurement menus**:

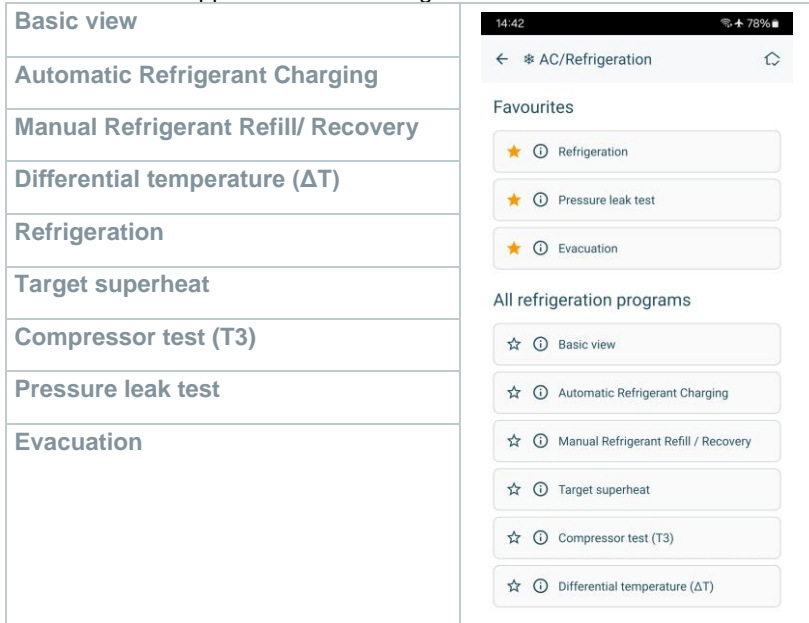

8.3.1 Basic view

In the **Basic view** application menu, the current measuring values can be read, recorded and saved. The Basic view is particularly suitable for fast, uncomplicated measurements without the specific requirements of a standard-compliant measurement.



All Bluetooth® probes compatible with the testo Smart App are displayed in the **Basic view** angezeigt.

In all application menus, apart from the volume flow measurement, there are three different screens for the measurement - Live (or also Basic view), Graphic and Table.





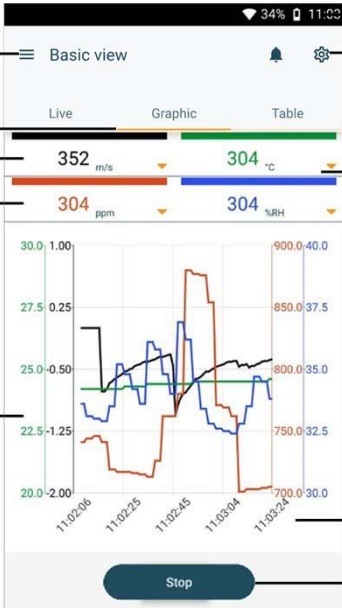

8.3.1.1 Graphic view

In the Graphic view, the values for a maximum 4 channels can be displayed simultaneously in a chronological trend graph. All measured parameters can be displayed in the Graphic view via the channel selection (click on one of the four selection fields). Once a measurement parameter has been selected, the value is updated automatically.

The Zoom touch function allows individual parts of the graphic to be viewed in more detail or time progressions to be displayed compactly.

1	 Open the main menu	
2	Change of display	
3	Reading for selected channel	
4	Measurement parameter and measurement unit	
5	Graphic with selected channels and 4 Y-axes	
6	Status bar	
7	 Open the configuration menu	
8	Selection of other channels	
9	Time axis	
10	New/Start/Stop/Save button	

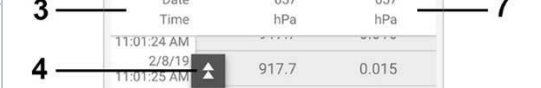
8.3.1.2 Table view

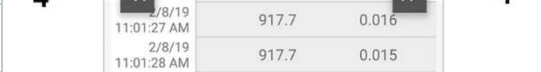
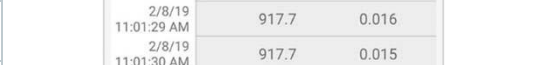
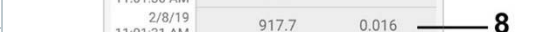
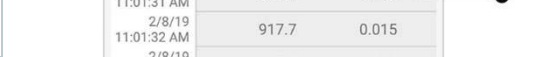
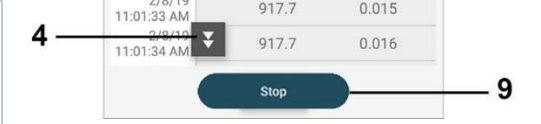
<p>1  Open the main menu</p>	
<p>2 Change of display</p>	
<p>3 Column with date and time</p>	
<p>4 Arrow keys to go directly to the end of the table</p>	
<p>5 Status bar</p>	
<p>6  Open the configuration menu</p>	
<p>7 Probe ID - measurement unit</p>	
<p>8 Measuring values</p>	
<p>9 New/Start/Stop/Save button</p>	
	

8.3.2 Refrigeration

The **Refrigeration** application is used to determine the following system measuring values:

- Low-pressure side: Evaporation pressure, refrigerant evaporation temperature to/Ev (T evap.)
- Evaporation pressure: Measured temperature toh/T1
- Evaporation pressure: Superheating Δ toh/SH
- High-pressure side: Condensation pressure, refrigerant condensation temperature tc/Co (T condens.)
- Condensation pressure: Measured temperature tcu/T2
- Condensation pressure: Subcooling Δ tcu/SC

With its integrated logging function the device can be left on the system and logging can be done without being on site.

This allows an intelligent error analysis in the testo Smart App.



The testo 115i clamp thermometer is used for the measurement.



An NTC temperature sensor (accessory) must be connected for measuring the pipe temperature and for automatic calculation of superheating and subcooling. Testo Smart Probes (e.g. testo 115i) can be used.



Before each measurement, check that the refrigerant hoses are in flawless condition.



Before each measurement, zero the pressure sensors. All connections must be pressureless (ambient pressure). Press the button [▲] (P=O) for 2 seconds to zero the sensors.

- 1 Click on **Measure**.
- 2 Click on **AC + Refrigeration**.
▶ The Refrigeration measurement menu opens.
- 3 Set refrigerant.



You have the option of setting up favourite refrigerants in the App. These then appear at the beginning of the refrigerant list. To do this, click on the asterisk next to the refrigerant in the refrigerant list (App).

- ▶ The newly set refrigerant is displayed in the refrigerant list.
- 4 Click on .

► Configuration menu opens.

5 Make the required settings.

To start a log-term measurement, activate the option **Long-term measurement with testo 570s**.

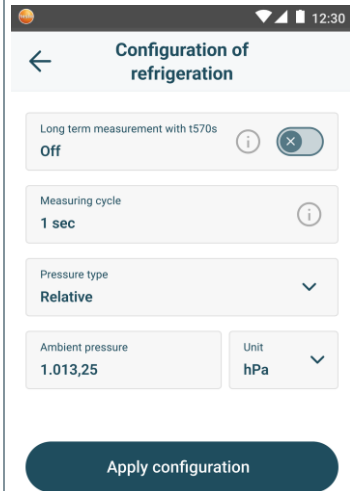

6 In case of **Automatic** start of long-term measurement, select **Start date** and **Start** (time).



For start type **Manual** the long-term measurement can be started via **Start long-term measurement** after closing the configuration menu.

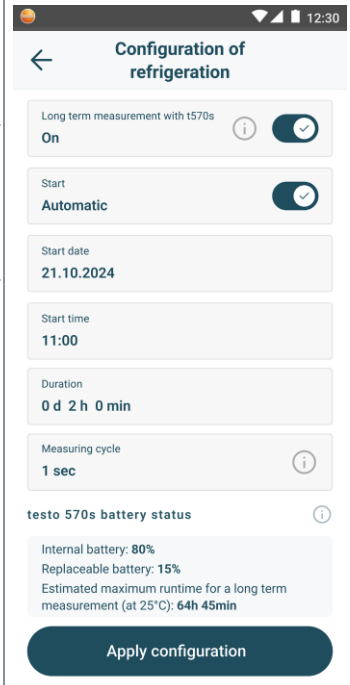

- ▶ If the long-term measurement option is enabled, the configuration menu shows the remaining battery and rechargeable battery capacity and the maximum possible duration of the long-term measurement.

testo 570s battery status
 Internal battery: 80%
 Rechargeable battery: 15%
 Estimated maximum runtime for a long-term measurement: 64 hr 45 min

- 7 Click on **Apply Configuration**.

- 8 Depending on whether immediate measurement or long-term measurement should be started:
 - Click on **Start**.
 - Click on **Start long-term measurement**.

- ▶ The measurement resp. long-term measurement starts.

In case of automatically started long-term measurement, the display shows after which duration the measurement will be started.

- ▶ Values currently being measured are displayed.



- ▶ Measured values can be saved or a new measurement can be started.



With zeotropic refrigerants, the evaporation temperature t_{oh}/Ev is displayed after complete evaporation/the condensation temperature t_{cu}/Co is displayed after complete condensation.

The measured temperature must be assigned to the superheating or subcooling side ($t_{oh} <--> t_{cu}$). Dependent on this assignment, the display will show $t_{oh}/T1$ resp. $\Delta t_{oh}/SH$ or $t_{cu}/T2$ resp. $\Delta t_{cu}/SC$, depending on the selected display.



Reading and display illumination flash:

- 1 bar/14.5 psi before reaching critical refrigerant pressure
- When max. permissible pressure of 60 bar(870 psi) is exceeded.

▶ After completing a long-term measurement the following options are available:

- **Save summarised data:** only summarized data will be saved.
- **Transfer & save complete data:** all recorded measurement results are transferred and saved in the app.
- **Delete data on manifold:** the recorded measurement results on the device will be deleted without transferring them to the app.

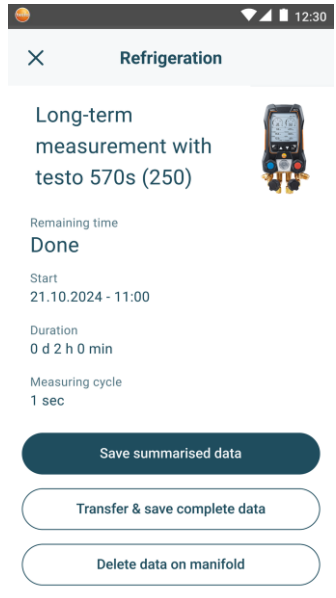

8.3.3 Target superheat

This feature allows the manifold to calculate the target superheat in conjunction with the App and additional testo 605i Smart Probes. This application can only be used for split air conditioning systems/heat pumps with a fixed expansion valve. The two connected testo 605i Smart Probes determine the ODDB and RAWB values. As a result, the target superheat appears in the App.



The following are used for the measurement:



- testo 115i (clamp thermometer)
- testo 605i



Before each measurement, check that the refrigerant hoses are in flawless condition.



Before each measurement, zero the pressure sensors.

- 1  Click on **Measure**.
- 2 Click on **Target superheat**.
 - ▶ The Target superheat measurement menu opens.
- 3 Click on .
- ▶ Configuration menu opens.

4 Make the required settings.

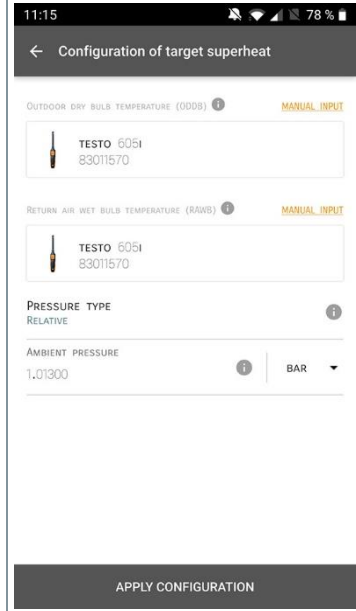

5 Click on Apply Configuration.

6 Set refrigerant.

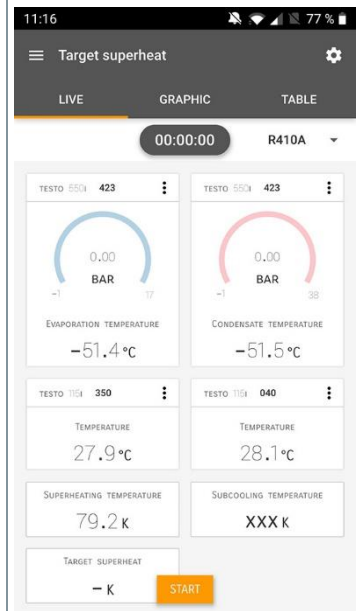

- ▶ The newly set refrigerant is displayed in the refrigerant list.
- 7 Click on **Start**.
- ▶ The measurement starts.
- ▶ Values currently being measured are displayed.
- ▶ Measured values can be saved or a new measurement can be started.

8.3.4 System Leak Test

The temperature compensated leakage test can be used to check the leak tightness of systems. For this purpose both the system pressure and the ambient temperature are measured over a defined period of time.





To this end, a temperature probe may be connected to measure the ambient temperature (recommendation: Deactivate the surface compensation factor and use an NTC air probe or Bluetooth® temperature Smart Probes) or Smart Probe for air temperature measurement. This provides information about the temperature-compensated differential pressure and the temperature at the beginning/end of the test. Due to the temperature compensation, the actual pressure drop is displayed as delta P. If no temperature probe is connected, you may also perform the tightness test without temperature compensation.



Surface temperature probes (e.g. testo 115i) can also be used for the temperature-compensated leakage test, but must not be used for measuring surface temperature. They must be positioned as far as possible to measure the air temperature.



The 550i, 550s, 557s, 558s or 570s manifold is used to perform the measurement.

- 1  Click on **Measure**.
- 2 Click on **Leakage test**.
- ▶ The **Leakage test** measurement menu opens.
- 3 Click on .
- ▶ Configuration menu opens.

4 Make the required settings.

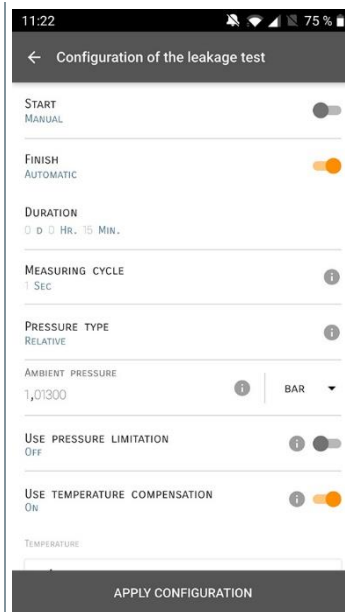

5 Click on **Apply Configuration**.

6 Click on **Start**.

▶ The measurement starts.

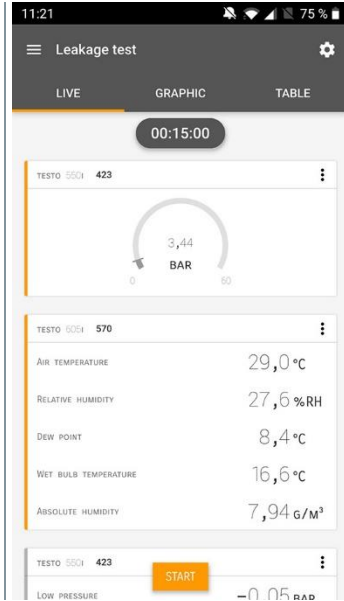

- ▶ Values currently being measured are displayed.



- ▶ Measured values are saved. The values can be exported or a report can be created.

8.3.5 Evacuation

With the Evacuation application, foreign gases and moisture can be removed from the refrigeration circuit.

- 1  Click on **Measure**.
- 2 Click on **Evacuation**.
- ▶ The **Evacuation** measurement menu opens.
- 3 Click on .
- ▶ Configuration menu opens.
- 4 Make the required settings.

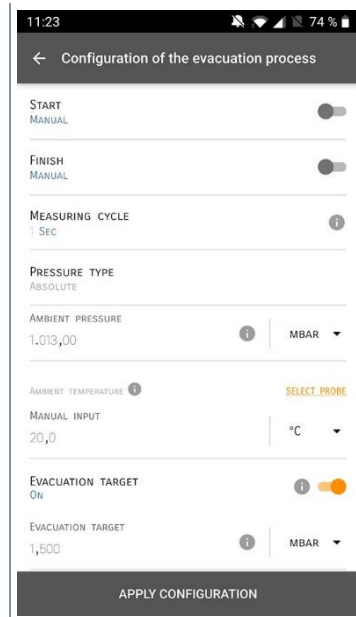

- 5 Click on **Apply Configuration**.
- 6 Click on **Start**.
- ▶ The measurement starts.

- ▶ Values currently being measured are displayed.

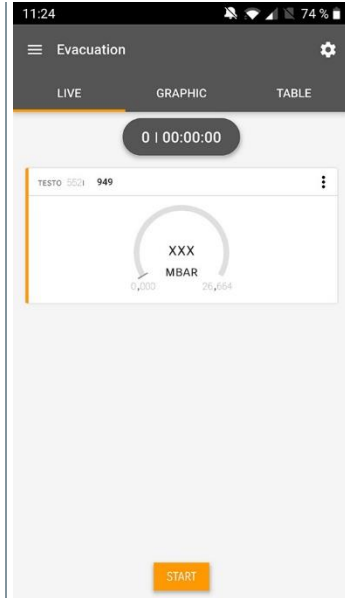



- ▶ Measured values can be saved or a new measurement can be started.

8.4 Customer

In the **Customer** menu, all customer and measuring site information can be created, edited and deleted. Fields marked with * are mandatory. Without any information in this field, no customers or measuring sites can be stored.

8.4.1 Creating and editing a customer

- 1 Click on .
- ▶ Main menu opens
- 2  Click on **Customer**.
- ▶ The Customer menu opens.
- 3 Click on **+ New Customer**.
- ▶ A new customer can be created.

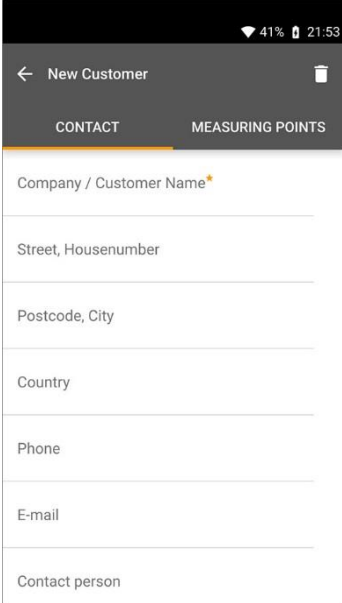

- 4 Store all relevant customer data.



The screenshot shows a mobile application interface for adding a new customer. At the top, there's a dark header with a back arrow, the title 'New Customer', and a trash icon. Below the header are two tabs: 'CONTACT' (highlighted with an orange underline) and 'MEASURING POINTS'. The form contains several input fields: 'Company / Customer Name*' (with a red asterisk), 'Street, Housenumber', 'Postcode, City', 'Country', 'Phone', 'E-mail', and 'Contact person'.

- 5 Click on **Save**.
- ▶ The new customer was saved.

8.4.2 Creating and editing measuring sites

- 1 Click on .
- ▶ Main menu opens
- 2  Click on **Customer**.
- ▶ The Customer menu opens.
- 3 Click on **+ New Customer**.
- 4 Click on the right tab **Measuring point**.
- 5 Click on **+ New Measuring Point**.

- ▶ A new measuring site can be created.
- 6 Store all relevant measuring site information.
- 7 Click on right tab **Parameters**.

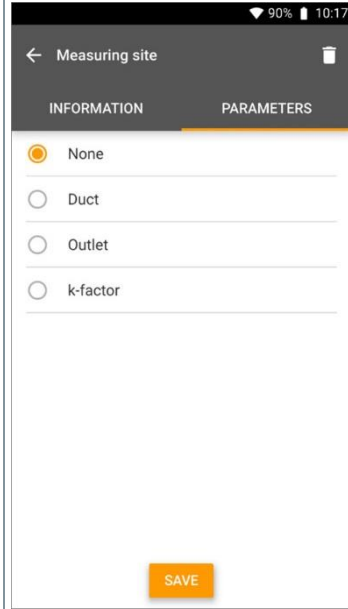

- 8 Select further parameters.



For the duct, outlet or duct with k-factor measuring sites, further parameter settings can be implemented.

- 9 Click on **Save**.
- ▶ The new measuring site has been saved.

8.5 Memory



In the **Memory** menu, you can call up all the measurements stored with the manifold, analyze them in detail and also create and save csv data and PDF reports. When clicking on a measurement, an overview of the measurement results is displayed.

8.5.1 Searching for and deleting measurement results

In the **Memory** menu, all stored measurements are sorted by date and time.

- ✓ The **Memory** menu is open.
- 1 Click on .
- ▶ Search field with measurements opens.
- 2 Enter the customer name or measuring site or date/time in the search field.
- ▶ The result is displayed.

Deleting

- 1 Click on .
- ▶ A check box is displayed in front of each measurement.
- 2 Click on the required measurement.
- ▶ A tick is displayed in the respective box.
- 3 Click on .
- ▶ Information window is displayed.
- 4 Acknowledge the information.
- ▶ Selected measurements were deleted.

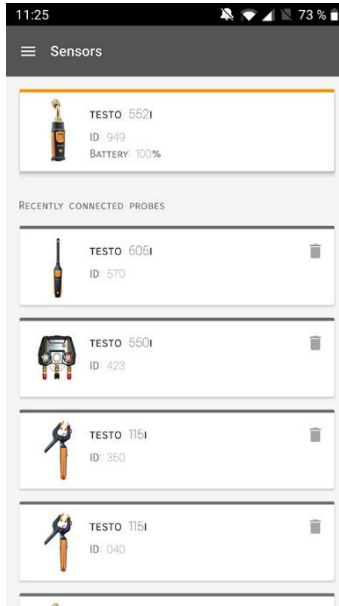

8.6 Sensors

All sensors used with the App can be found in the  **Sensors** menu. There, you can view general information about currently connected probes as well as recently connected probes.





8.6.1 Information

Information is stored for each probe.

- ✓ The App is connected to the manifold.
- 1 Click on .
 - ▶ Main menu opens.
- 2  Click on **Sensors**.
 - ▶ The Sensors menu opens.
- 3 Click on one of the displayed probes.
 - ▶ Information is displayed about the model, order number, serial number and firmware version.

8.6.2 Settings

Settings can also be made for each probe.

- ✓ The probe is connected to the App.
- 1 Click on .
- ▶ Main menu opens.
- 2  Click on **Sensors**.
- ▶ The Sensors menu opens.
- 3 Click on one of the displayed probes.
- 4 Click on the Settings tab.
- 5 Click on one of the displayed probes.
- ▶ Settings appear that can be changed if necessary.

8.7 Settings

8.7.1 Language



- 1  Click on **Settings**.
- ▶ The **Settings** menu opens.
- 2 Click on **Language**.
- ▶ A window with different languages opens.
- 3 Click on the required language.
- ▶ The required language is set.

8.7.2 Measurement settings



- 1  Click on **Settings**.
- ▶ The Settings menu opens.

- 2 Click on **Measurement settings**.
- ▶ A window with different basic settings for measurement opens.
- 3 Click on the required settings and change if necessary.
- ▶ The required measurement settings are set.
- 4  Exit **Measurement settings**.

8.7.3 Company details

- 1  Click on **Settings**.
- ▶ The Settings menu opens.
- 2 Click on **Company details**.
- ▶ A window with company details opens.
- 3 Click on the required data and enter if necessary.
- ▶ The required company details are set.
- 4  Exit **Company details**.

8.7.4 Privacy settings

- 1  Click on **Settings**.
- ▶ The Settings menu opens.
- 2 Click on **Privacy settings**.
- ▶ A window with privacy settings opens.
- 3 Activate or deactivate the required settings.
- ▶ The required settings are set.
- 4  Exit **Privacy settings**.

8.8 Help and Information

Under Help and Information, you will find information about the testo 550i, and the tutorial can be called up and implemented. This also where legal information can be found.

8.8.1 Instrument information

- 1  Click on **Help and Information**.
 - ▶ The Help and Information menu opens.
- 2 Click on **Instrument information**.
 - ▶ The current App version, Google Analytics instance ID, refrigerant version and update are displayed for the connected instrument.

Automatic updates for instruments can be enabled or disabled.

- ▶ Use the slider to activate or deactivate **Update for connected instruments**.

8.8.2 Tutorial

- 1  Click on **Help and Information**.
 - ▶ The Help and Information menu opens.
- 2 Click on **Tutorial**.
 - ▶ The tutorial shows you the most important steps prior to commissioning.

8.8.3 Exclusion of liability

- 1  Click on **Help and Information**.
 - ▶ The Help and Information menu opens.
- 2 Click on **Exclusion of liability**.
 - ▶ The data protection information and licence usage information is displayed.

8.9 testo DataControl archiving software

The free testo DataControl measurement data management and analysis software enhances the functionality of the testo Smart App measuring instrument with lots of useful functions:

- Manage and archive customer data and measuring site information
- Read out, evaluate and archive measurement data
- Presenting readings in graphic form
- Create professional measurement reports from the existing measurement data
- Conveniently add pictures and comments to measurement reports
- Data import from and data export to the measuring instrument

8.9.1 System requirements



Administrator rights are required for installation.

8.9.1.1 Operating system

The software can be run on the following operating systems:

- Windows® 7
- Windows® 8
- Windows® 10

8.9.1.2 PC

The computer must meet the requirements of the operating system in each case. The following requirements must also be met:

- Interface USB 2 or higher
- DualCore processor with minimum 1 GHz
- Minimum 2 GB RAM
- Minimum 5 GB available hard disk space
- Screen with a resolution of at least 800 x 600 pixels

8.9.2 Procedure

- ✓ To transfer the data from the App to testo DataControl, both instruments must be in the same network.
For example: A notebook with installed testo DataControl and a smartphone with installed testo Smart App are connected to the same WLAN.
- 1 Open testo Smart App on the smartphone or tablet.
- 2 Open the testo DataControl archiving software on the PC.
- 3 Click on **Select instrument**.

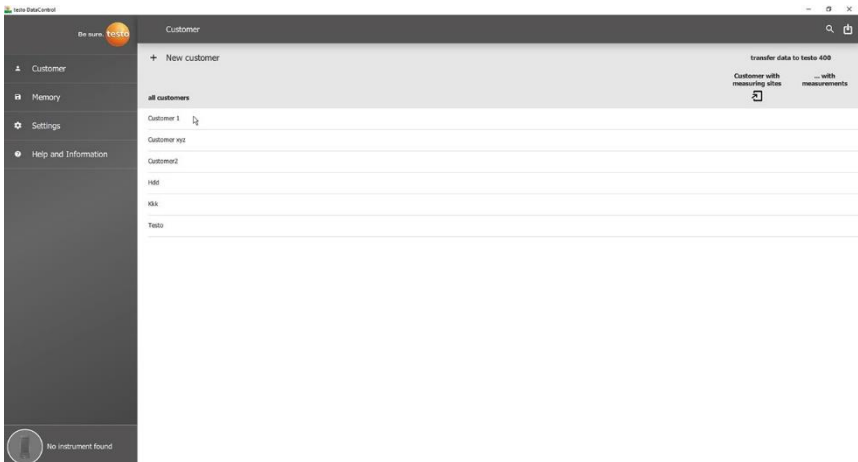

- ▶ An overview with available instruments opens.

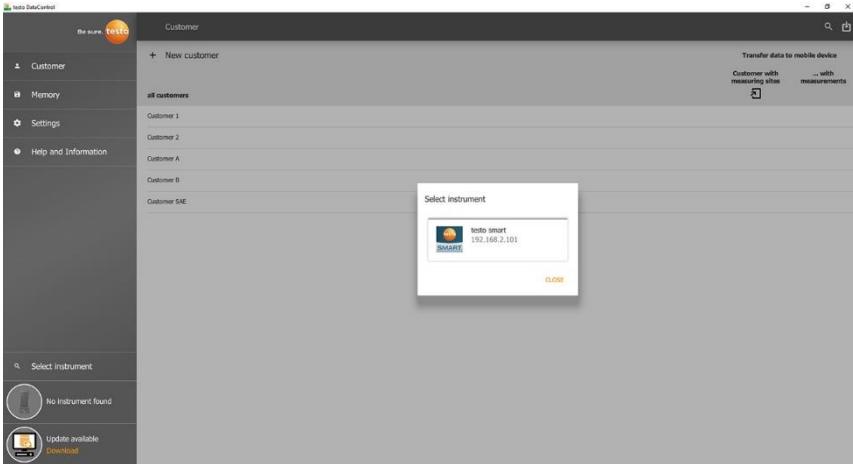

- 4 Select instrument.
- ▶ A safety notice is displayed.

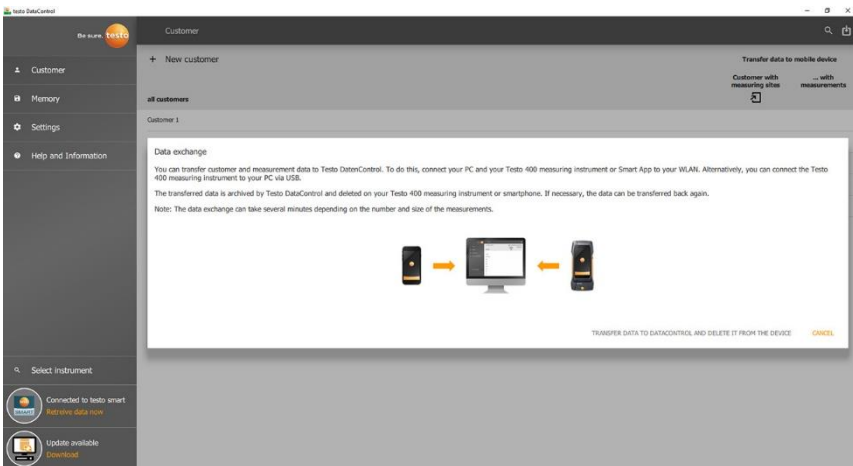

- 5 Click on **Transfer data to DataControl and delete from instrument.**
- ▶ Data has been successfully transferred.

9 Maintenance

9.1 Calibration



The testo 558s is supplied with a factory calibration certificate as standard.

Recalibration once every 12 months is recommended in many applications.

This can be carried out by Testo Industrial Services (TIS) or other certified service providers.

Please contact Testo for further information.

9.2 Cleaning the instrument



Do not use any aggressive cleaning agents or solvents! Mild household cleaning agents and soap suds may be used.

- > If the housing of the instrument is dirty, clean it with a damp cloth.

9.3 Keeping connections clean

- > Keep screw connections clean and free of grease and other deposits; clean with a damp cloth as required.

9.4 Removing oil residues

- > Carefully blow out oil residues in the valve block using compressed air.

9.5 Ensuring measuring accuracy

Testo Customer Service will be happy to help you as required.

- > Check the instrument regularly for leaks. Keep to the permissible pressure range!
- > Calibrate the instrument regularly (recommendation: once a year).

9.6 Changing batteries batteries

✓ The instrument is switched off.

- 1 Fold out the suspension hook, release the clip and remove the battery compartment lid.



- 2 Remove the spent batteries and insert new ones (3 x AA alkaline) into the battery compartment. Observe the polarity!
- 3 Attach and close the battery compartment lid (the clip must click into place).
- 4 Switch the instrument on.

9.7 Removing the permanently installed battery



The following steps should only be carried out if the device is defective and is to be disposed of.

Any necessary replacement of the permanently installed battery should be carried out by testo customer service

✓ Device is switched off.

1 Remove the red and blue control knobs.

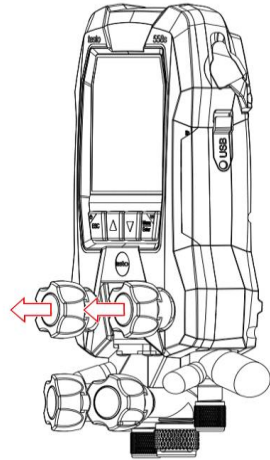

2 Fold out the suspension device, release the clip, remove the battery compartment cover and remove the batteries.



- 3 Loosen the 6 marked screws and remove the back of the device.

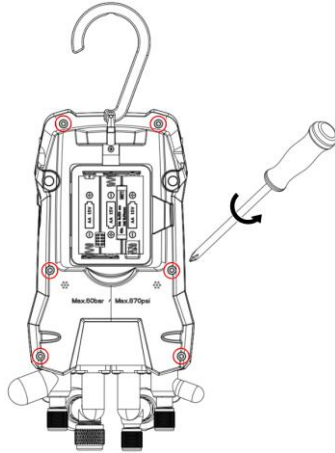

- 4 Disconnect the battery connector on the circuit board.

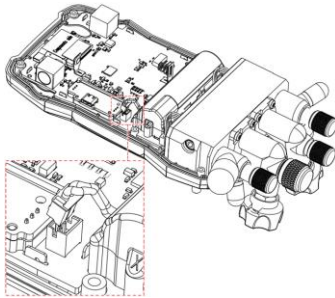

- 5 Remove the valve block and circuit board from the front half of the housing.

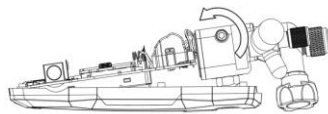

- 6 Loosen the two marked screws to remove the battery housing.

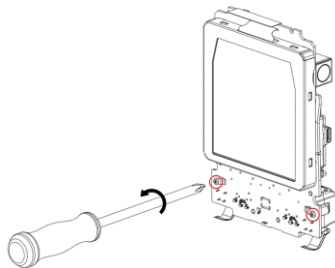

- 7 Open the battery housing with pliers.

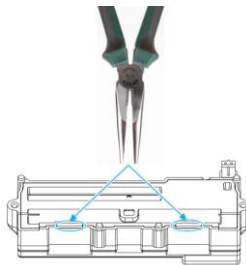

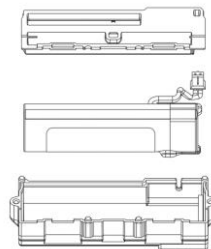

- 8 Remove the battery from the housing.



10 Technical data

Feature	Value
Measurement parameters	Pressure: kPa/MPa/bar/psi Temperature: °C/°F/K Vacuum: hPa / mbar/ Torr / mTorr / inH ₂ O / micron / inHg / Pa
Sensor	Connections: 4 Valves: 4
	Pressure: 2 x pressure sensor Temperature: 2 x NTC Vacuum: via external probe Up to 4 Smart Probes via Bluetooth® connection
Measuring cycle	0.5 s
Interfaces	Pressure ports: 3 x 7/16" UNF, 1 x 5/8" UNF NTC measurement External vacuum probe
Measuring ranges	HP/LP pressure measuring range: -100 to 6000 kPa/-0.1 to 6 Mpa/-1 to 60 bar (rel)/-14.7 to 870 psi Temperature measuring range: -50 to +150 °C / -58 to 302 °F Temperature measuring range of testo 115i: -40 to +150 °C / -40 to 302 °F Vacuum measuring range: 0 to 20,000 microns
Overload	65 bar; 6500 kPa; 6.5 MPa; 940 psi
Resolution	Resolution pressure: 0.01 bar/0.1 psi/1 kPa/0.001 Mpa Resolution temperature: 0.1 °C / 0.1 °F / 0.1 K Vacuum resolution: 1 micron (from 0 to 1000 microns) 10 microns (from 1000 to 2000 microns) 100 microns (from 2000 to 5000 microns) 500 microns (from 5000 to 10,000 microns) 5000 microns (from 10,000 to 20,000 microns)
Accuracy (nominal temperature 22 °C/71.6 °F)	Pressure: ±0.25% of full scale value (±1 digit) Temperature (-50 to 150 °C): ±0.5 °C (±1 digit), ±0.9 °F (±1 digit), testo 115i temperature: ±2.3 °F (-4 to 185 °F) / ±1.3 °C (-20 to +85 °C), Vacuum: ±(10 microns + 10% of m.v.) (100 to 1000 microns)

Feature	Value
Intelligent logging function	<ul style="list-style-type: none"> - Logging duration time: 1 ... 72 hours. - Measurement cycle: 1 ... 60 s. - Intelligent logging data: App read logging data in fast way via BLE (25 s in typical use case) - Very accurate logging timestamp: ≤ 5 s/72 hours @ -20 ... 50 °C
Measurable media	Measurable media: all media that are stored in the testo 570s. Not measurable: ammonia (R717) and other refrigerants which contain ammonia.
Ambient conditions	<p>Operating temperature: -20 to 50 °C / -4 to 122 °F -10 to 50 °C / 14 to 122 °F (vacuum)</p> <div style="border: 1px solid gray; padding: 5px; margin: 5px 0;">  At operating temperatures below -16 °C, batteries must be inserted, as the internal battery switches off at temperatures below -16 °C. </div> <p>Storage temperature: -20 to 60 °C / -4 to 140 °F Humidity application range: 10 to 90 %RH</p>
Housing	<p>Material: ABS/PA/TPE Dimensions: approx. 235 x 121 x 80 mm Weight: 930 g (without batteries)</p>
IP class	54
Power supply	<p>Internal Battery: 3400mAh 18650 Lithium battery in device</p> <ul style="list-style-type: none"> - Battery lifetime @ 25°C: <ul style="list-style-type: none"> >=70 h MCU+BLE+LCD+50 % Backlight (all-time) >=90 h MCU+BLE+LCD+50 % Backlight (half-time) >=130 h MCU+BLE+LCD >=190 h MCU+LCD. - Fast charge: achieve 80 % capacity in 1.5 hours. - charge ambient temperature range: 0 .. 35 °C <p>Exchangeable Batteries: 3 x 1.5 V type AA alkaline battery</p> <ul style="list-style-type: none"> - Battery lifetime @ 25°C:

Feature	Value
	>=55 h MCU+BLE+LCD+50 % Backlight (all-time) >=75 h MCU+BLE+LCD+50% Backlight (half-time) >=110 h MCU+BLE+LCD >=145 h MCU+LCD.)
Auto off	30 min, if enabled
Display	type: Illuminated LCD Response time: 0.5 s
Directives, standards and tests	EU Directive: 2014/30/EU  Testo SE & Co. KGaA hereby declares that the testo 558s (0564 5581) comply with Directive 2014/53/EU. The full text of the EU Declaration of Conformity can be found on the following website: https://www.testo.com/eu-conformity .

Available refrigerants

Feature	Value		
No. of refrigerants	~ 90		
Selectable refrigerants in the instrument	R114	R407C	R444B
	R12	R407F	R448A
	R123	R407H	R449A
	R1233zd	R408A	R450A
	R1234yf	R409A	R452A
	R1234ze	R410A	R452B
	R124	R414B	R453a
	R125	R416A	R454A
	R13	R420A	R454B
	R134a	R421A	R454C
	R22	R421B	R455A
	R23	R422B	R458A
	R290	R422C	R500
	R32	R422D	R502
	R401A	R424A	R503
	R401B	R427A	R507
	R402A	R434A	R513A
	R402B	R437A	R600a
	R404A	R438A	R718 (H2O)
	R407A	R442A	R744 (CO2)
	R11	R227	R417A
	FX80	R236fa	R417B
	I12A	R245fa	R417C
	R1150	R401C	R422A
	R1270	R406A	R426A
	R13B1	R407B	R508A
	R14	R407D	R508B
	R142B	R41	R600
	R152a	R411A	RIS89
	R161	R412A	SP22
R170	R413A		

11 Tips and assistance

11.1 Questions and answers

Question	Possible causes/solution
 flashes	Rechargeable battery and/or exchangeable batteries are almost empty. > Recharge battery/Change the exchangeable batteries.
The device switches itself off.	Residual capacity of rechargeable battery/exchangeable batteries too low. > Recharge battery/Change the exchangeable batteries.
Below range lights up instead of the measurement parameter display	The value is below the permissible measuring range. > Keep within the permissible measuring range.
Above range lights up instead of the measurement parameter display	The value is above the permissible measuring range. > Keep within the permissible measuring range.

11.2 Error Codes

11.2.1 Main screen

Code	Possible cause / solution
E 12	Please long press the [ESC] Power key >20s to reset the device. If the error is still available, please contact our service department.
E 13	
E 14	
E 15	
E 16	
E 30	testo 558s still runs the old firmware version. If you want use the latest version, please update again. If the error is still available, please contact our service department.
E 31	testo 558s still runs the old refrigerant file version. If you want use the latest version, please update it again. If the error is still available, please contact our service department.
E 32	Please long press the [ESC] Power key >20s to reset the device. If the error is still available, please contact our service department.

11.2.2 Status view

Code	Possible cause / solution
E 10	Please long press the [ESC] Power key >20s to reset the device. If the error is still available, please contact our service department.
E 11	
E 72	testo 558s battery is too low to support the current application. please charge the battery/Replace the AA battery.
E 74	Please long press the [ESC] Power key >20s to reset the device. If the error is still available, please contact our service department.

11.3 Accessories and spare parts

Description	Order no.
Clamp probe for temperature measurement on pipes (1.5 m)	0613 5505
Clamp probe for temperature measurement on pipes (5 m)	0613 5506
2 x clamp temperature probes kit (NTC) for digital manifolds	0613 5507
Pipe wrap probe with Velcro tape for pipe diameters of up to max. 75 mm, Tmax +75 °C, NTC	0613 4611
Water tight NTC surface probe	0613 1912
Precise, robust NTC air probe	0613 1712
Spare valve set	0554 5570
Magnetic strap	0564 1001
External vacuum probe	0564 2552
USB mains unit with cable	0554 1107

For a complete list of all accessories and spare parts, please refer to the product catalogues and brochures or visit our website www.testo.com

12 Support

You can find up-to-date information on products, downloads and links to contact addresses for support queries on the Testo website at: www.testo.com.

If you have any questions please contact your local dealer or the Testo Customer Service. You can find contact details on the back of this document or online at www.testo.com/service-contact.



Testo SE & Co. KGaA

Celsiusstr. 2

79822 Titisee-Neustadt

Germany

Phone: +49 (0)7653 681-0

E-mail: info@testo.de

www.testo.com